



# API

Flanged Safety Relief Valves  
Series 526

# CATALOG

**LESER**

[The-Safety-Valve.com](http://The-Safety-Valve.com)

## Valve finder

### How to find the right product group

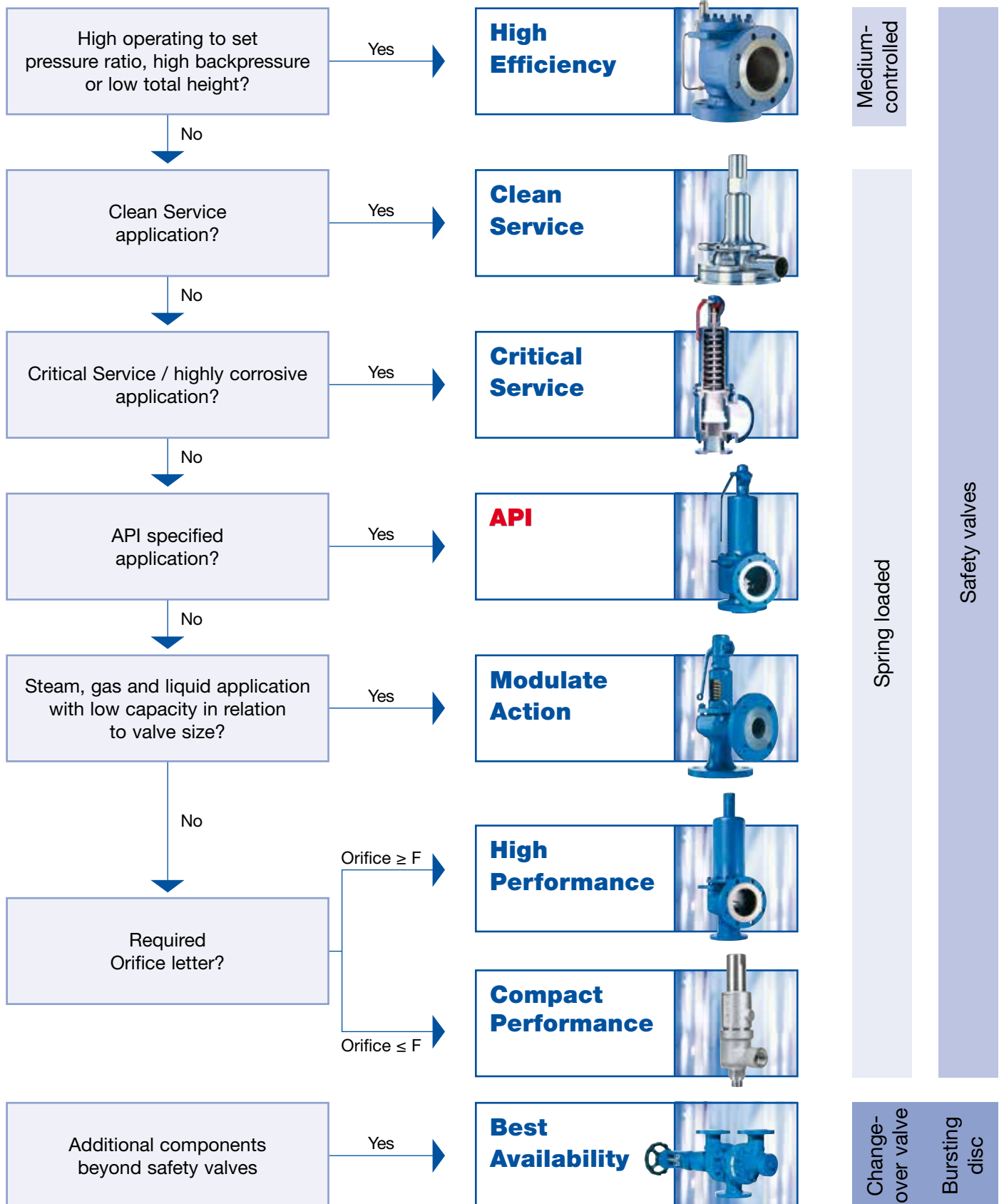

## Contents

	Page
<b>General</b>	<b>2</b>
Valve finder	2
General Information	4
<b>Type 526</b>	<b>5</b>
<b>Materials</b>	
• Conventional design	6
• Balanced bellows design	8
<b>Article numbers</b>	
• Overview	12
<b>Dimensions</b>	
• Metric units	16
• US units	18
<b>Weights</b>	
• Metric units	16
• US units	17
<b>Orifice D – T</b>	
• Pressure temperature ratings [Metric + US units]	18
Available options	46
Flange drillings	48
Outlet flange rating class 300	50
Flange facings	53
LESER Original Spare Parts Kits	54
Approvals	55

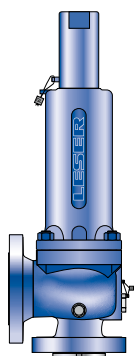

Cap H2  
Closed bonnet  
Conventional design

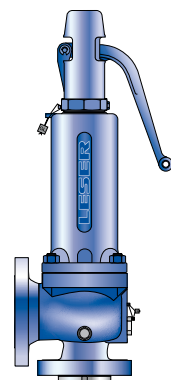

Plain lever H3  
Closed bonnet  
Conventional design

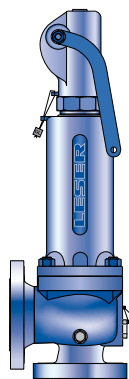

Packed lever H4  
Closed bonnet  
Conventional design

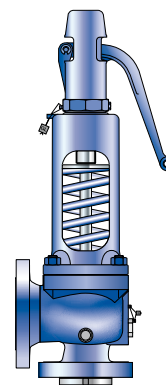

Plain lever H3  
Open bonnet  
Conventional design

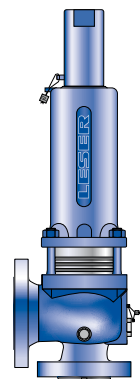

Cap H2  
Closed bonnet  
Balanced bellows design

## General Information

The API product group represents

- ✓ Full range of spring loaded safety valves acc. to API 526
- ✓ State-of-the-art design from the safety valve specialist
- ✓ Competitive solutions for the API market

### API safety valves from LESER

- Are designed to meet all applications which require API.
- Open rapidly with an overpressure of max. 10 % to the full design lift.
- Have a maximum blowdown of 7 % for steam/gas service and 20 % for liquid service.
- Are developed in a close cooperation with plant engineers and service specialists.
- Serve for protection of processes and equipment.
- Are approved by all important approval organisations worldwide which ensures the worldwide applicability e.g.:
  - European Community: CE-marking acc. to Pressure Equipment Directive (PED) 97 / 23 / EC and EN ISO 4126-1
  - USA: UV-stamp acc. to ASME Section VIII Division 1, National Board certified capacities
  - Germany: VdTÜV approval acc. to PED, EN ISO 4126-1, TÜV SV 100 and AD 2000-Merkblatt A2
  - Canada: Canadian Registration Number acc. to the requirements of particular provinces
  - China: AQSIQ based on the approval acc. to ASME Section VIII Division 1 and AD 2000-Merkblatt A2
  - Eurasian Custom Union: Approval acc. to Eurasian Custom Union (EAC - Eurasian Conformity)

Furthermore, all LESER API safety valves are designed, marked, produced and approved acc. to the requirements of the following regulations (directives, codes, rules and standards).

EN ISO 4126-7, EN 12266-1/-2, EN 1092 Part I and II flanging ASME PTC 25, ASME-Code Sec. II, ASME B 16.34 and ASME B16.5- flanging, API Std. 527, API RP 576, AD 2000-Merkblatt A4, AD 2000-Merkblatt HP0

## Applications

LESER – API safety valves offer ultimate protection against overpressure in all applications for steam, gases and liquids.

LESER's API Series safety valves present the simple safe solution for heavy duty applications, such as crude oil extraction, transportation and processing in

- Refineries
- Chemical industry
- Petrochemical industry
- Oil and gas – Onshore and Offshore
- Vessels and piping systems
- Blow-down systems
- Storage tank farms

## General design features

LESER's API Series covers a large variety of types, materials and options to fit any application:

- Design fully in accordance with API 526 for easy interchangeability
- Complete API 526 range: valve sizes 1" through 8", orifice D through T
- Materials: WCB, WCC, CF8M, WC6, LCB, LCC, and a wide range of special materials to fulfill the requirements of critical applications
- Special B<sup>3</sup> design for high back pressure applications and material requirements far beyond API Standard
- Fool proof design with fewer parts for built-in safety
- Integral cast support brackets for easy handling and safe installation
- Open or closed bonnet, packed or plain lifting lever or gastight cap
- Flanged connections according ASME and DIN guarantee a worldwide applicability
- One design and spring (single trim) for steam, gas and liquid applications reduces the number of spare parts and ensures low cost maintenance management.
- One-piece spindle reduces friction which leads to high operation accuracy
- Self-draining body design, avoids residues and reduces corrosion
- Horizontal installation

## Options

- Special connections specified by the customer for optimised adaptation to the plant.
- Stellite or hardened metal sealing for longer product life
- Soft seat solutions for superior tightness
- Balanced bellows for back pressure compensation
- Heating jackets for applications with high viscosity fluids
- Any and every part can be produced in special material exactly to meet customer specification requirements



**Type 526**  
**Flanged Safety Relief Valves**  
**– spring loaded**



<b>Contents</b>	<b>Page</b>
<b>Materials</b>	
• Conventional design	6
• Balanced bellows design	8
<b>Article numbers</b>	
• Overview	10
<b>Dimensions</b>	
• Metric units	12
• US units	14
<b>Weights</b>	
• Metric units	16
• US units	17
<b>Orifice D – T</b>	
• Pressure temperature ratings [Metric units + US units]	18
Available options	46
Flange drillings	48
Outlet flange rating class 300	50
Flange facings	53
LESER Original Spare Parts Kits	54
Approvals	55

**Type 526**  
**Packed lever H4**  
**Closed bonnet**  
**Conventional design**

**Type 526**  
**Conventional design**

Type 526

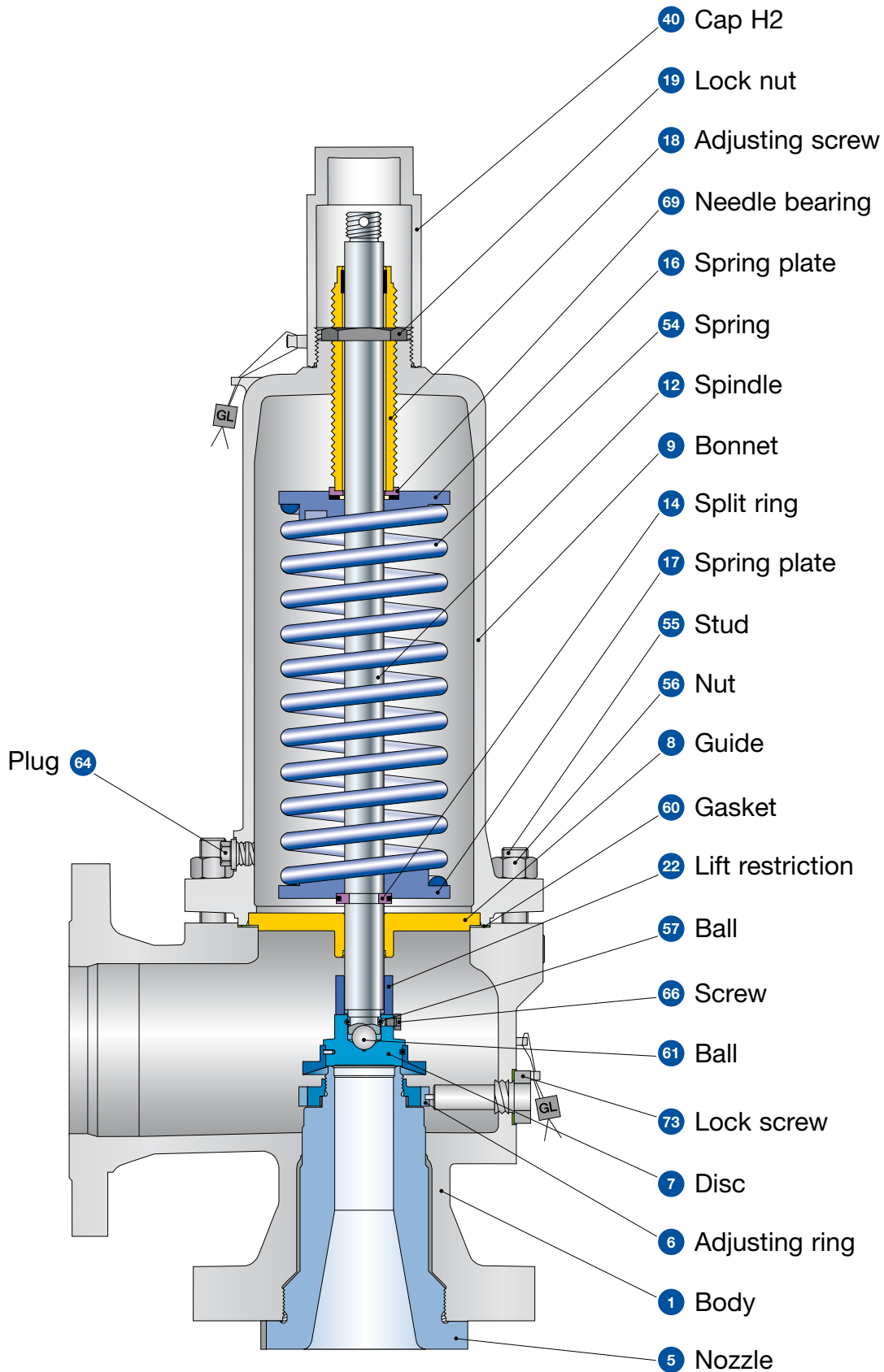

## Type 526

### Conventional design

#### Materials

Item	Component	Standard Service Type 5262 Trim: Standard	Corrosive Service Type 5264 Trim: Standard	Type 5267 Trim: Standard	Type 5263 Trim: Standard
1	Body	1.0619	1.4408	1.7357	
		SA 216 WCB	SA 351 CF8M	SA 217 WC6	SA 352 LCB
5	Nozzle <sup>1)</sup>	1.4408	1.4408	1.4408 stellited	1.4408
		CF8M	CF8M	CF8M stellited	CF8M
6	Adjusting ring	1.4408	1.4408	1.4408	1.4408
		CF8M	CF8M	CF8M	CF8M
7	Disc	1.4122	1.4404 stellited	1.4122	1.4122
		Hardened stainless steel	316L stellited	Hardened stainless steel	Hardened stainless steel
8	Guide with bushing	1.0501	1.4404	1.4404	1.0501
		Steel	316L	316L	Steel
		1.4104 tenifer	-	-	1.4104 tenifer
		Chrome steel tenifer	-	-	Chrome steel tenifer
9	Bonnet	1.0619	1.4408 <sup>2)</sup>	1.7357	
		SA 216 WCB	SA 351 CF8M	SA 217 WC6	SA 352 LCB
		1.0305 <sup>4)</sup>	1.4571 / 1.4404 <sup>3)</sup>	1.0305 <sup>4)</sup>	1.0305 <sup>4)</sup>
	Steel	SA 479 316Ti / 316L	Steel	Steel	
12	Spindle	1.4021	1.4404	1.4021	1.4021
		420	316L	420	420
14	Split ring	1.4104	1.4404	1.4104	1.4104
		Chrome steel	316L	Chrome steel	Chrome steel
16 / 17	Spring plate	1.0718 <sup>3)</sup>	1.4404	1.0718 <sup>5)</sup>	1.0718 <sup>5)</sup>
		Steel	316L	Steel	Steel
18	Adjusting screw with bushing	1.4104	1.4404 tenifer	1.4104	1.4104
		Chrome steel	316L tenifer	Chrome steel	Chrome steel
		PTFE 15% glass	PTFE 15% glass	PTFE 15% glass	PTFE 15% glass
		PTFE 15% glass	PTFE 15% glass	PTFE 15% glass	PTFE 15% glass
19	Lock nut	1.0718	1.4404	1.0718	1.0718
		Steel	316L	Steel	Steel
22	Lift restriction	1.4404	1.4404	1.4404	1.4404
		316L	316L	316L	316L
40	Cap H2	1.0460 / 0.7040	1.4404	1.0460 / 0.7040	1.0460 / 0.7040
		SA 105 / Gr. 60-40-18	316L	SA 105 / Gr. 60-40-18	SA 105 / Gr. 60-40-18
54	Spring	1.7102, 1.8159	1.4310	1.7102, 1.8159	1.7102, 1.8159
		High temp. alloy steel	Stainless steel	High temp. alloy steel	High temp. alloy steel
55	Stud	1.4401	1.4401	1.4401	1.4401
		B8M	B8M	B8M	B8M
56	Nut	1.4401	1.4401	1.4401	1.4401
		8M	8M	8M	8M
57	Ball	1.4401	1.4401	1.4401	1.4401
		316	316	316	316
60	Gasket	Graphite / 1.4401	Graphite / 1.4401	Graphite / 1.4401	Graphite / 1.4401
		Graphite / 316	Graphite / 316	Graphite / 316	Graphite / 316
61	Ball	1.3541	1.4401	1.3541	1.3541
		Hardened stainless steel	316	Hardened stainless steel	Hardened stainless steel
64	Plug	Steel	1.4401	Steel	Steel
		Steel	B8M	Steel	Steel
66	Screw	1.4401	1.4401	1.4401	1.4401
		B8M	B8M	B8M	B8M
69	Needle bearing	1.4404	1.4404	1.4404	1.4404
		316L	316 L	316L	316L
73	Lock screw	1.4404	1.4404	1.4404	1.4404
		316L	316L	316L	316L

<sup>1)</sup> Stellited sealing surfaces please refer to page 102 Extended Catalog. LESER reserves also to use the nozzle material 1.4404 / 316L. <sup>2)</sup> Valve sizes up to 2" <sup>3)</sup> Valve sizes ≥ 3"  
<sup>4)</sup> Valve size 6 R 10, 8 T 10 and 6 Q 8 in high pressure design (Option code Z90). <sup>5)</sup> For valve sizes 6 Q 8, 6 R 10 and 8 T 10 in high pressure design: 1.4122 / chrome steel.

**Please notice:**

- Modifications reserved by LESER.
- If several materials are specified LESER defines the material.
- LESER can upgrade materials without notice.
- Every part can be replaced by other material acc. to customer specification.

**Special materials:**

See API Alloy Concept page 80, Extended Catalog.

**Type 526**

**Balanced bellows design**

Type 526

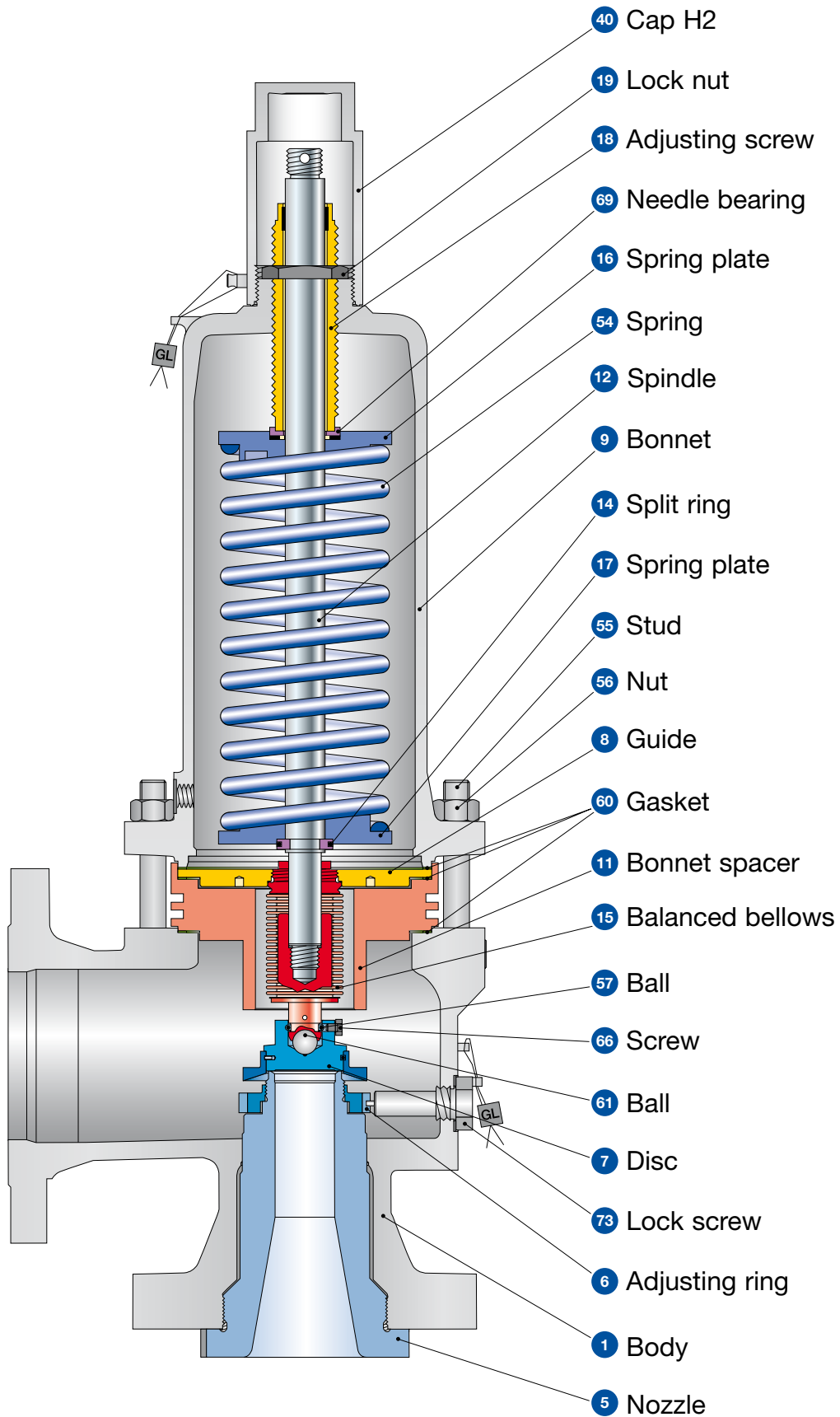



## Type 526

### Balanced bellows design

#### Materials

Item	Component	Standard Service Type 5262 Trim: Standard	Corrosive Service Type 5264 Trim: Standard	Type 5267 Trim: Standard	Type 5263 Trim: Standard
1	Body	1.0619 SA 216 WCB	1.4408 SA 351 CF8M	1.7357 SA 217 WC6	SA 352 LCB
5	Nozzle <sup>1)</sup>	1.4408 CF8M	1.4408 CF8M	1.4408 stellite CF8M stellite	1.4408 CF8M
6	Adjusting ring	1.4408 CF8M	1.4408 CF8M	1.4408 CF8M	1.4408 CF8M
7	Disc	1.4122 Hardened stainless steel	1.4404 stellite 316L stellite	1.4122 Hardened stainless steel	1.4122 Hardened stainless steel
8	Guide	1.4404 316 L	1.4404 316L	1.4404 316L	1.4404 316L
9	Bonnet	1.0619 SA 216 WCB 1.0305 <sup>4)</sup> Steel	1.4408 <sup>2)</sup> SA 351 CF8M 1.4571 / 1.4404 <sup>3)</sup> SA 479 316Ti / 316L	1.7357 SA 217 WC6 1.0305 <sup>4)</sup> Steel	SA 352 LCB 1.0305 <sup>4)</sup> Steel
11	Bonnet spacer <sup>5)</sup>	1.0460 SA 105	1.4404 <sup>7)</sup> SA 479 316L	1.4404 <sup>7)</sup> SA 479 316L	1.4404 <sup>7)</sup> SA 479 316L
12	Spindle	1.4021 420	1.4404 316L	1.4021 420	1.4021 420
14	Split ring	1.4104 Chrome steel	1.4404 316L	1.4104 Chrome steel	1.4104 Chrome steel
15	Bellows	End pieces 2.4856 Inconel 625	1.4404 316L	2.4856 Inconel 625	1.4404 316L
16 / 17	Spring plate	1.0718 <sup>4)</sup> Steel	1.4404 316L	1.0718 <sup>6)</sup> Steel	1.0718 <sup>6)</sup> Steel
18	Adjusting screw with bushing	1.4104 Chrome steel PTFE 15% glass PTFE 15% glass	1.4404 tenifer 316L tenifer PTFE 15% glass PTFE 15% glass	1.4104 Chrome steel PTFE 15% glass PTFE 15% glass	1.4104 Chrome steel PTFE 15% glass PTFE 15% glass
19	Lock nut	1.0718 Steel	1.4404 316L	1.0718 Steel	1.0718 Steel
40	Cap H2	1.0460 / 0.7040 SA 105 / Gr. 60-40-18	1.4404 316L	1.0460 / 0.7040 SA 105 / Gr. 60-40-18	1.0460 / 0.7040 SA 105 / Gr. 60-40-18
54	Spring	1.7102, 1.8159 High temp. alloy steel	1.4310 Stainless steel	1.7102, 1.8159 High temp. alloy steel	1.7102, 1.8159 High temp. alloy steel
55	Stud	1.4401 B8M	1.4401 B8M	1.7709 B16	1.4401 B8M
56	Nut	1.4401 8M	1.4401 8M	1.7258 7M	1.4401 8M
57	Ball	1.4401 316	1.4401 316	1.4401 316	1.4401 316
60	Gasket	Graphite / 1.4401 Graphite / 316	Graphite / 1.4401 Graphite / 316	Graphite / 1.4401 Graphite / 316	Graphite / 1.4401 Graphite / 316
61	Ball	1.3541 Hardened stainless steel	1.4401 316	1.3541 Hardened stainless steel	1.3541 Hardened stainless steel
66	Screw	1.4401 B8M	1.4401 B8M	1.4401 B8M	1.4401 B8M
69	Needle bearing	1.4404 316L	1.4404 316L	1.4404 316L	1.4404 316L
73	Lock screw	1.4404 316L	1.4404 316L	1.4404 316L	1.4404 316L

<sup>1)</sup> Stellite sealing surfaces please refer to page 102 Extended Catalog. LESER reserves also to use the nozzle material 1.4404 / 316L. <sup>2)</sup> Valve sizes up to 2" <sup>3)</sup> Valve sizes ≥ 3"

<sup>4)</sup> Valve size 6 R 10, 8 T 10 and 6 Q 8 in high pressure design (Option code Z90). <sup>5)</sup> Valve size 1 1/2 D 3, 1 1/2 E 3, 1 1/2 F 3, 6 R 10 and 8 T 10 without bonnet spacer.

<sup>6)</sup> For valve sizes 6 Q 8, 6 R 10 and 8 T 10 in high pressure design: 1.4122 / chrome steel. <sup>7)</sup> LESER reserves also to use material 1.4408/CF8M.

#### Please notice:

- Modifications reserved by LESER.
- If several materials are specified LESER defines the material.
- LESER can upgrade materials without notice.
- Every part can be replaced by other material acc. to customer specification.

#### Special materials:

See API Alloy Concept page 80, Extended Catalog.

## Type 526

### Article numbers

#### Overview

Material	WCB	CF8M	WC6	LCB	WCB	CF8M	WC6	LCB	WCB	CF8M	WC6	LCB
	1.0619	1.4408	1.7357		1.0619	1.4408	1.7357		1.0619	1.4408	1.7357	
<b>Flange class</b>	150 x 150				300L x 150				300 x 150			
<b>Valve size</b>	1 D 2				1 D 2				1 D 2			
<b>D</b>	5262.001 <sup>o</sup>	5264.010 <sup>o</sup>	-	5263.500 <sup>o</sup>	Use 1 D 2 300 x 150				5262.002 <sup>o</sup>	5264.011 <sup>o</sup>	5267.006 <sup>o</sup>	5263.501 <sup>o</sup>
<b>E</b>	1 E 2				1 E 2				1 E 2			
	5262.015 <sup>o</sup>	5264.024 <sup>o</sup>	-	5263.505 <sup>o</sup>	Use 1 E 2 300 x 150				5262.016 <sup>o</sup>	5264.025 <sup>o</sup>	5267.020 <sup>o</sup>	5263.506 <sup>o</sup>
<b>F</b>	1 1/2 F 2				1 1/2 F 2				1 1/2 F 2			
	5262.029 <sup>o</sup>	5264.039 <sup>o</sup>	-	5263.510 <sup>o</sup>	5262.030 <sup>o</sup>	5264.040 <sup>o</sup>	-	5263.511 <sup>o</sup>	5262.031 <sup>o</sup>	5264.041 <sup>o</sup>	5267.035 <sup>o</sup>	5263.512 <sup>o</sup>
<b>G</b>	1 1/2 G 3				1 1/2 G 3				1 1/2 G 3			
	5262.045 <sup>o</sup>	5264.110 <sup>o</sup>	-	5263.516 <sup>o</sup>	5262.046 <sup>o</sup>	5264.111 <sup>o</sup>	-	5263.517 <sup>o</sup>	5262.047 <sup>o</sup>	5264.112 <sup>o</sup>	5267.052 <sup>o</sup>	5263.518 <sup>o</sup>
<b>Flange class</b>	150 x 150				300L x 150				300 x 150			
<b>Valve size</b>	1 1/2 H 3				1 1/2 H 3				2 H 3			
<b>H</b>	5262.142 <sup>o</sup>	5264.152 <sup>o</sup>	-	5263.523 <sup>o</sup>	5262.143 <sup>o</sup>	5264.153 <sup>o</sup>	-	5263.524 <sup>o</sup>	5262.144 <sup>o</sup>	5264.154 <sup>o</sup>	5267.148 <sup>o</sup>	5263.525 <sup>o</sup>
<b>J</b>	2 J 3				2 J 3				3 J 4			
	5262.162 <sup>o</sup>	5264.196 <sup>o</sup>	-	5263.529 <sup>o</sup>	5262.163 <sup>o</sup>	5264.197 <sup>o</sup>	-	5263.530 <sup>o</sup>	5262.164 <sup>o</sup>	5264.198 <sup>o</sup>	5267.168 <sup>o</sup>	5263.531 <sup>o</sup>
<b>K</b>	3 K 4				3 K 4				3 K 4			
	5262.202 <sup>o</sup>	5264.211 <sup>o</sup>	-	5263.535 <sup>o</sup>	Use 3 K 4 300 x 150				5262.203 <sup>o</sup>	5264.212 <sup>o</sup>	5267.207 <sup>o</sup>	5263.536 <sup>o</sup>
<b>Flange class</b>	150 x 150				300L x 150				300 x 150			
<b>Valve size</b>	3 L 4				3 L 4				4 L 6			
<b>L</b>	5262.232 <sup>o</sup>	5264.242 <sup>o</sup>	-	5263.540 <sup>o</sup>	5262.233 <sup>o</sup>	5264.243 <sup>o</sup>	-	5263.541 <sup>o</sup>	5262.234 <sup>o</sup>	5264.244 <sup>o</sup>	5267.238 <sup>o</sup>	5263.542 <sup>o</sup>
<b>M</b>	4 M 6				4 M 6				4 M 6			
	5262.580 <sup>o</sup>	5264.587 <sup>o</sup>	-	5263.546 <sup>o</sup>	Use 4 M 6 300 x 150				5262.581 <sup>o</sup>	5264.588 <sup>o</sup>	5267.584 <sup>o</sup>	5263.547 <sup>o</sup>
<b>N</b>	4 N 6				4 N 6				4 N 6			
	5262.590 <sup>o</sup>	5264.597 <sup>o</sup>	-	5263.550 <sup>o</sup>	Use 4 N 6 300 x 150				5262.591 <sup>o</sup>	5264.598 <sup>o</sup>	5267.594 <sup>o</sup>	5263.551 <sup>o</sup>
<b>P</b>	4 P 6				4 P 6				4 P 6			
	5262.645 <sup>o</sup>	5264.653 <sup>o</sup>	-	5263.554 <sup>o</sup>	5262.646 <sup>o</sup>	5264.654 <sup>o</sup>	-	5263.555 <sup>o</sup>	5262.647 <sup>o</sup>	5264.655 <sup>o</sup>	5267.650 <sup>o</sup>	5263.556 <sup>o</sup>
<b>Q</b>	6 Q 8				6 Q 8				6 Q 8			
	5262.657 <sup>o</sup>	5264.662 <sup>o</sup>	-	5263.559 <sup>o</sup>	Use 6 Q 8 300 x 150				5262.658 <sup>o</sup>	5264.663 <sup>o</sup>	5267.660 <sup>o</sup>	5263.560 <sup>o</sup>
<b>R</b>	6 R 8				6 R 8				6 R 10			
	5262.665 <sup>o</sup>	5264.671 <sup>o</sup>	-	5263.562 <sup>o</sup>	5262.666 <sup>o</sup>	5264.672 <sup>o</sup>	5267.669 <sup>o</sup>	5263.563 <sup>o</sup>	5262.667 <sup>o</sup>	5264.673 <sup>o</sup>	-	5263.564 <sup>o</sup>
<b>T</b>	8 T 10				8 T 10				8 T 10			
	5262.675 <sup>o</sup>	5264.678 <sup>o</sup>	-	5263.566 <sup>o</sup>	Use 8 T 10 300 x 150				5262.676 <sup>o</sup>	5264.679 <sup>o</sup>	5267.677 <sup>o</sup>	5263.567 <sup>o</sup>

Material	WCB	CF8M	WC6	LCB	WCB	CF8M	WC6	LCB	WCB	CF8M	WC6	LCB	WCB	CF8M	WC6	LCB
	1.0619	1.4408	1.7357		1.0619	1.4408	1.7357		1.0619	1.4408	1.7357		1.0619	1.4408	1.7357	
<b>Flange class</b>	600 x 150				900 x 300				1500 x 300				2500 x 300			
<b>Valve size</b>	1 D 2				1 1/2 D 2				1 1/2 D 2				1 1/2 D 3			
<b>D</b>	5262.003 <sup>o</sup>	5264.012 <sup>o</sup>	5267.007 <sup>o</sup>	5263.502 <sup>o</sup>	Use 1 1/2 D 2 1500 x 300				5262.004 <sup>o</sup>	5264.013 <sup>o</sup>	5267.008 <sup>o</sup>	5263.503 <sup>o</sup>	5262.005 <sup>o</sup>	5264.014 <sup>o</sup>	5267.009 <sup>o</sup>	5263.504 <sup>o</sup>
<b>E</b>	1 E 2				1 1/2 E 2				1 1/2 E 2				1 1/2 E 3			
<b>E</b>	5262.017 <sup>o</sup>	5264.026 <sup>o</sup>	5267.021 <sup>o</sup>	5263.507 <sup>o</sup>	Use 1 1/2 E 2 1500 x 300				5262.018 <sup>o</sup>	5264.027 <sup>o</sup>	5267.022 <sup>o</sup>	5263.508 <sup>o</sup>	5262.019 <sup>o</sup>	5264.028 <sup>o</sup>	5267.023 <sup>o</sup>	5263.509 <sup>o</sup>
<b>F</b>	1 1/2 F 2				1 1/2 F 3				1 1/2 F 3				1 1/2 F 3			
<b>F</b>	5262.032 <sup>o</sup>	5264.042 <sup>o</sup>	5267.036 <sup>o</sup>	5263.513 <sup>o</sup>	Use 1 1/2 F 3 1500 x 300				5262.033 <sup>o</sup>	5264.043 <sup>o</sup>	5267.037 <sup>o</sup>	5263.514 <sup>o</sup>	5262.034 <sup>o</sup>	5264.044 <sup>o</sup>	5267.038 <sup>o</sup>	5263.515 <sup>o</sup>
<b>G</b>	1 1/2 G 3				1 1/2 G 3				2 G 3				2 G 3			
<b>G</b>	5262.048 <sup>o</sup>	5264.113 <sup>o</sup>	5267.053 <sup>o</sup>	5263.519 <sup>o</sup>	5262.049 <sup>o</sup>	5264.114 <sup>o</sup>	5267.054 <sup>o</sup>	5263.520 <sup>o</sup>	5262.050 <sup>o</sup>	5264.115 <sup>o</sup>	5267.055 <sup>o</sup>	5263.521 <sup>o</sup>	5262.051 <sup>o</sup>	5264.116 <sup>o</sup>	5267.056 <sup>o</sup>	5263.522 <sup>o</sup>
<b>Flange class</b>	600 x 150				900 x 150				1500 x 300							
<b>Valve size</b>	2 H 3				2 H 3				2 H 3							
<b>H</b>	5262.145 <sup>o</sup>	5264.155 <sup>o</sup>	5267.149 <sup>o</sup>	5263.526 <sup>o</sup>	5262.146 <sup>o</sup>	5264.156 <sup>o</sup>	5267.150 <sup>o</sup>	5263.527 <sup>o</sup>	5262.147 <sup>o</sup>	5264.157 <sup>o</sup>	5267.151 <sup>o</sup>	5263.528 <sup>o</sup>				
<b>J</b>	3 J 4				3 J 4				3 J 4							
<b>J</b>	5262.165 <sup>o</sup>	5264.199 <sup>o</sup>	5267.169 <sup>o</sup>	5263.532 <sup>o</sup>	5262.166 <sup>o</sup>	5264.200 <sup>o</sup>	5267.170 <sup>o</sup>	5263.533 <sup>o</sup>	5262.167 <sup>o</sup>	5264.201 <sup>o</sup>	5267.171 <sup>o</sup>	5263.534 <sup>o</sup>				
<b>K</b>	3 K 4				3 K 6				3 K 6							
<b>K</b>	5262.204 <sup>o</sup>	5264.213 <sup>o</sup>	5267.208 <sup>o</sup>	5263.537 <sup>o</sup>	5262.205 <sup>o</sup>	5264.214 <sup>o</sup>	5267.209 <sup>o</sup>	5263.538 <sup>o</sup>	5262.206 <sup>o</sup>	5264.215 <sup>o</sup>	5267.210 <sup>o</sup>	5263.539 <sup>o</sup>				
<b>Flange class</b>	600 x 150				900 x 150				1500 x 150							
<b>Valve size</b>	4 L 6				4 L 6				4 L 6							
<b>L</b>	5262.235 <sup>o</sup>	5264.245 <sup>o</sup>	5267.239 <sup>o</sup>	5263.543 <sup>o</sup>	5262.236 <sup>o</sup>	5264.246 <sup>o</sup>	5267.240 <sup>o</sup>	5263.544 <sup>o</sup>	5262.237 <sup>o</sup>	-	5267.241 <sup>o</sup>	5263.545 <sup>o</sup>				
<b>M</b>	4 M 6				4 M 6											
<b>M</b>	5262.582 <sup>o</sup>	5264.589 <sup>o</sup>	5267.585 <sup>o</sup>	5263.548 <sup>o</sup>	5262.583 <sup>o</sup>	-	5267.586 <sup>o</sup>	5263.549 <sup>o</sup>								
<b>N</b>	4 N 6				4 N 6											
<b>N</b>	5262.592 <sup>o</sup>	5264.599 <sup>o</sup>	5267.595 <sup>o</sup>	5263.552 <sup>o</sup>	5262.593 <sup>o</sup>	-	5267.596 <sup>o</sup>	5263.553 <sup>o</sup>								
<b>P</b>	4 P 6				4 P 6											
<b>P</b>	5262.648 <sup>o</sup>	5264.656 <sup>o</sup>	5267.651 <sup>o</sup>	5263.557 <sup>o</sup>	5262.649 <sup>o</sup>	-	5267.652 <sup>o</sup>	5263.558 <sup>o</sup>								
<b>Q</b>	6 Q 8															
<b>Q</b>	5262.659 <sup>o</sup>	5264.664 <sup>o</sup>	5267.661 <sup>o</sup>	5263.561 <sup>o</sup>												
<b>R</b>	6 R 10															
<b>R</b>	5262.668 <sup>o</sup>	5264.674 <sup>o</sup>	5267.670 <sup>o</sup>	5263.565 <sup>o</sup>												
<b>T</b>	8 T 10															
<b>T</b>	-	-	-	-												

<sup>o</sup> Please add code for the required cap or lifting device.

Code for lifting device				
Lifting device	H2	H3	H4	H3
Bonnet	closed	closed	closed	open
WCB 1.0619, WC6 1.7357, LCB	2	3	4	5
CF8M 1.4408	2	-	4	-

## Type 526

### Dimensions

Metric units

Safety valve dimensions		[mm]	a	b	s	H <sub>max.</sub>	H <sub>max.</sub> with bellows	a	b	s	H <sub>max.</sub>	H <sub>max.</sub> with bellows	a	b	s	H <sub>max.</sub>	H <sub>max.</sub> with bellows
Support brackets		[mm]	A	B	C	D	E	A	B	C	D	E	A	B	C	D	E
<b>Flange rating class</b>			<b>150 x 150</b>					<b>300L x 150</b>					<b>300 x 150</b>				
<b>Valve size</b>			1 D 2					1 D 2					1 D 2				
<b>D</b>	d <sub>0</sub> [mm]	<b>14.0</b>	105	114	30	440	465	Please see 1 D 2					105	114	30	440	465
	A <sub>0</sub> [mm <sup>2</sup> ]	<b>154</b>	130	–	Ø 14	132	16	300 x 150					130	–	Ø 14	132	16
<b>Valve size</b>			1 E 2					1 E 2					1 E 2				
<b>E</b>	d <sub>0</sub> [mm]	<b>14.0</b>	105	114	30	440	465	Please see 1 E 2					105	114	30	440	465
	A <sub>0</sub> [mm <sup>2</sup> ]	<b>154</b>	130	–	Ø 14	132	16	300 x 150					130	–	Ø 14	132	16
<b>Valve size</b>			1 1/2 F 2					1 1/2 F 2					1 1/2 F 2				
<b>F</b>	d <sub>0</sub> [mm]	<b>18.0</b>	124	121	32	536	561	124	121	32	536	561	124	152	35	536	561
	A <sub>0</sub> [mm <sup>2</sup> ]	<b>254</b>	162	–	Ø 14	148	16	162	–	Ø 14	148	16	162	–	Ø 14	148	16
<b>Valve size</b>			1 1/2 G 3					1 1/2 G 3					1 1/2 G 3				
<b>G</b>	d <sub>0</sub> [mm]	<b>22.5</b>	124	121	32	536	574	124	121	32	536	574	124	152	35	536	574
	A <sub>0</sub> [mm <sup>2</sup> ]	<b>398</b>	162	–	Ø 14	148	16	162	–	Ø 14	148	16	162	–	Ø 14	148	16
<b>Flange rating class</b>			<b>150 x 150</b>					<b>300L x 150</b>					<b>300 x 150</b>				
<b>Valve size</b>			1 1/2 H 3					1 1/2 H 3					2 H 3				
<b>H</b>	d <sub>0</sub> [mm]	<b>28.3</b>	130	124	38	542	580	130	124	38	542	580	130	124	43	666	692
	A <sub>0</sub> [mm <sup>2</sup> ]	<b>629</b>	162	–	Ø 14	155	16	162	–	Ø 14	155	16	184	110	Ø 14	177	16
<b>Valve size</b>			2 J 3					2 J 3					3 J 4				
<b>J</b>	d <sub>0</sub> [mm]	<b>36.0</b>	137	124	49	673	722	137	124	49	673	722	184	181	49	786	824
	A <sub>0</sub> [mm <sup>2</sup> ]	<b>1018</b>	184	110	Ø 14	184	16	184	110	Ø 14	184	16	238	140	Ø 18	234	25
<b>Valve size</b>			3 K 4					3 K 4					3 K 4				
<b>K</b>	WCB, LCB, d <sub>0</sub> [mm]	<b>43.0</b>	156	162	49	758	796	Please see 3 K 4					156	162	49	758	796
	CF8M (WC6) A <sub>0</sub> [mm <sup>2</sup> ]	<b>1452</b>	238	140	Ø 18	206	25	300 x 150					238	140	Ø 18	206	25
<b>WC6</b>																	
<b>Flange rating class</b>			<b>150 x 150</b>					<b>300L x 150</b>					<b>300 x 150</b>				
<b>Valve size</b>			3 L 4					3 L 4					4 L 6				
<b>L</b>	d <sub>0</sub> [mm]	<b>53.5</b>	156	165	49	758	796	156	165	49	758	796	179	181	49	853	886
	A <sub>0</sub> [mm <sup>2</sup> ]	<b>2248</b>	238	140	Ø 18	206	25	238	140	Ø 18	206	25	278	160	Ø 18	262	25
<b>Valve size</b>			4 M 6					4 M 6					4 M 6				
<b>M</b>	d <sub>0</sub> [mm]	<b>60.3</b>	178	184	48	852	885	Please see 4 M 6					178	184	48	852	885
	A <sub>0</sub> [mm <sup>2</sup> ]	<b>2856</b>	278	160	Ø 18	260	25	300 x 150					278	160	Ø 18	260	25
<b>Valve size</b>			4 N 6					4 N 6					4 N 6				
<b>N</b>	d <sub>0</sub> [mm]	<b>66.0</b>	197	210	48	871	904	Please see 4 N 6					197	210	48	871	904
	A <sub>0</sub> [mm <sup>2</sup> ]	<b>3421</b>	278	160	Ø 18	280	25	300 x 150					278	160	Ø 18	280	25
<b>Valve size</b>			4 P 6					4 P 6					4 P 6				
<b>P</b>	d <sub>0</sub> [mm]	<b>80.0</b>	181	229	48	855	888	181	229	48	855	888	225	254	62	1079	1138
	A <sub>0</sub> [mm <sup>2</sup> ]	<b>5027</b>	278	160	Ø 18	262	25	278	160	Ø 18	262	25	370	210	Ø 18	306	25
<b>Valve size</b>			6 Q 8					6 Q 8					6 Q 8				
<b>Q</b>	d <sub>0</sub> [mm]	<b>105.5</b>	240	241	68	1120	1200	Please see 6 Q 8					240	241	68	1120	1200
	A <sub>0</sub> [mm <sup>2</sup> ]	<b>8742</b>	370	210	Ø 18	346	25	300 x 150					370	210	Ø 18	346	25
<b>Valve size</b>			6 R 8					6 R 8					6 R 10				
<b>R</b>	d <sub>0</sub> [mm]	<b>126.0</b>	240	241	68	1120	1200	240	241	68	1120	1200	240	267	68	1426	1426
	A <sub>0</sub> [mm <sup>2</sup> ]	<b>12568</b>	370	210	Ø 18	346	25	370	210	Ø 18	346	25	470	150	Ø 18	460	25
<b>Valve size</b>			8 T 10					8 T 10					8 T 10				
<b>T</b>	d <sub>0</sub> [mm]	<b>161.5</b>	276	279	62	1462	1462	Please see 8 T 10					276	279	62	1462	1462
	A <sub>0</sub> [mm <sup>2</sup> ]	<b>20485</b>	470	150	Ø 18	497	25	300 x 150					470	150	Ø 18	497	25

$d_0$  = Actual orifice diameter  
 $A_0$  = Actual orifice area

a	b	s	H <sub>max.</sub>	H <sub>max.</sub> with bellows	a	b	s	H <sub>max.</sub>	H <sub>max.</sub> with bellows	a	b	s	H <sub>max.</sub>	H <sub>max.</sub> with bellows	a	b	s	H <sub>max.</sub>	H <sub>max.</sub> with bellows
A	B	C	D	E	A	B	C	D	E	A	B	C	D	E	A	B	C	D	E
<b>600 x 150</b>					<b>900 x 300</b>					<b>1500 x 300</b>					<b>2500 x 300</b>				
1 D 2					1 1/2 D 2					1 1/2 D 2					1 1/2 D 3				
105	114	30	440	465	Please see 1 1/2 D 2 1500 x 300					105	140	44	517	542	140	178	57	576	576
130	-	Ø 14	132	16						162	-	Ø 14	129	16	162	-	Ø 14	189	16
1 E 2					1 1/2 E 2					1 1/2 E 2					1 1/2 E 3				
105	114	30	440	465	Please see 1 1/2 E 2 1500 x 300					105	140	44	517	542	140	178	57	576	576
130	-	Ø 14	132	16						162	-	Ø 14	129	16	162	-	Ø 14	189	16
1 1/2 F 2					1 1/2 F 3					1 1/2 F 3					1 1/2 F 3				
124	152	35	536	561	Please see 1 1/2 F 3 1500 x 300					124	165	44	560	560	140	178	57	576	576
162	-	Ø 14	148	16						162	-	Ø 14	174	16	162	-	Ø 14	189	16
1 1/2 G 3					1 1/2 G 3					2 G 3					2 G 3				
124	152	35	536	574	124	165	44	560	573	156	172	68	688	705	156	172	68	688	705
162	-	Ø 14	148	16	162	-	Ø 14	174	16	184	110	Ø 14	198	16	184	110	Ø 14	198	16
<b>600 x 150</b>					<b>900 x 150</b>					<b>1500 x 300</b>									
2 H 3					2 H 3					2 H 3									
154	162	56	691	717	154	162	56	691	717	154	162	56	691	717					
184	110	Ø 14	202	16	184	110	Ø 14	202	16	184	110	Ø 14	202	16					
3 J 4					3 J 4					3 J 4									
184	181	49	786	824	184	181	65	786	824	184	181	65	786	824					
238	140	Ø 18	234	25	238	140	Ø 18	234	25	238	140	Ø 18	234	25					
3 K 4					3 K 6					3 K 6									
184	181	49	786	824	198	216	67	880	880	197	216	65	879	879					
238	140	Ø 18	234	25	278	160	Ø 18	288	25	278	160	Ø 18	287	25					
156	162	49	758	796															
238	140	Ø 18	206	25															
<b>600 x 150</b>					<b>900 x 150</b>					<b>1500 x 150</b>									
4 L 6					4 L 6					4 L 6									
179	203	57	853	886	197	222	72	871	904	197	222	72	871	904					
278	160	Ø 18	262	25	278	160	Ø 18	280	25	278	160	Ø 18	280	25					
4 M 6					4 M 6					4 M 6									
178	203	56	852	885	197	222	72	871	904	197	222	72	871	904					
278	160	Ø 18	260	25	278	160	Ø 18	280	25	278	160	Ø 18	280	25					
4 N 6					4 N 6					4 N 6									
197	222	72	871	904	197	222	72	871	904	197	222	72	871	904					
278	160	Ø 18	280	25	278	160	Ø 18	280	25	278	160	Ø 18	280	25					
4 P 6					4 P 6					4 P 6									
225	254	62	1079	1138	225	254	62	1079	1138	225	254	62	1079	1138					
370	210	Ø 18	306	25	370	210	Ø 18	306	25	370	210	Ø 18	306	25					
6 Q 8					6 Q 8					6 Q 8									
240	241	68	1120 <sup>1)</sup>	1200 <sup>2)</sup>															
370	210	Ø 18	346	25															
6 R 10					6 R 10					6 R 10									
240	267	68	1426	1426															
470	150	Ø 18	460	25															
-	-	-	-	-															
-	-	-	-	-															
-	-	-	-	-															

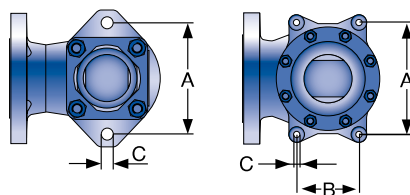

Support brackets

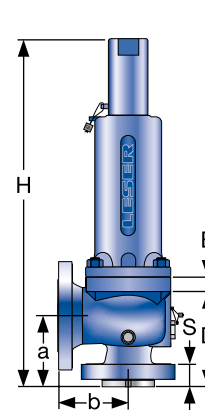

Conventional design

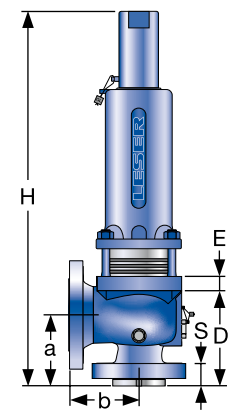

Balanced bellows design

<sup>1)</sup> Type 526 high pressure design: 1202  
<sup>2)</sup> Type 526 high pressure design: 1282

# Type 526

## Dimensions

US units

Safety valve dimensions		[inch]					[inch]					[inch]					
		a	b	s	H <sub>max.</sub>	H <sub>max.</sub> with bellows	a	b	s	H <sub>max.</sub>	H <sub>max.</sub> with bellows	a	b	s	H <sub>max.</sub>	H <sub>max.</sub> with bellows	
Support brackets		[inch]					[inch]					[inch]					
		A	B	C	D	E	A	B	C	D	E	A	B	C	D	E	
<b>Flange rating class</b>		<b>150 x 150</b>					<b>300L x 150</b>					<b>300 x 150</b>					
<b>Valve size</b>		1 D 2					1 D 2					1 D 2					
<b>D</b>	d <sub>0</sub> [inch]	<b>0.551</b>	4 1/8	4 1/2	1 3/16	17 5/16	18 5/16	Please see 1 D 2					4 1/8	4 1/2	1 3/16	17 5/16	18 5/16
	A <sub>0</sub> [inch <sup>2</sup> ]	<b>0.239</b>	5 1/8	-	Ø 9/16	5 7/32	5/8	300 x 150					5 1/8	-	Ø 9/16	5 7/32	5/8
<b>Valve size</b>		1 E 2					1 E 2					1 E 2					
<b>E</b>	d <sub>0</sub> [inch]	<b>0.551</b>	4 1/8	4 1/2	1 3/16	17 5/16	18 5/16	Please see 1 E 2					4 1/8	4 1/2	1 3/16	17 5/16	18 5/16
	A <sub>0</sub> [inch <sup>2</sup> ]	<b>0.239</b>	5 1/8	-	Ø 9/16	5 7/32	5/8	300 x 150					5 1/8	-	Ø 9/16	5 7/32	5/8
<b>Valve size</b>		1 1/2 F 2					1 1/2 F 2					1 1/2 F 2					
<b>F</b>	d <sub>0</sub> [inch]	<b>0.709</b>	4 7/8	4 3/4	1 1/4	21 3/32	22 3/32	4 7/8	4 3/4	1 1/4	21 3/32	22 3/32	4 7/8	6	1 13/32	21 3/32	22 3/32
	A <sub>0</sub> [inch <sup>2</sup> ]	<b>0.394</b>	6 3/8	-	Ø 9/16	5 27/32	5/8	6 3/8	-	Ø 9/16	5 27/32	5/8	6 3/8	-	Ø 14	5 27/32	5/8
<b>Valve size</b>		1 1/2 G 3					1 1/2 G 3					1 1/2 G 3					
<b>G</b>	d <sub>0</sub> [inch]	<b>0.886</b>	4 7/8	4 3/4	1 1/4	21 3/32	22 19/32	4 7/8	4 3/4	1 1/4	21 3/32	22 19/32	4 7/8	6	1 13/32	21 3/32	22 19/32
	A <sub>0</sub> [inch <sup>2</sup> ]	<b>0.616</b>	6 3/8	-	Ø 9/16	5 27/32	5/8	6 3/8	-	Ø 9/16	5 27/32	5/8	6 3/8	-	Ø 9/16	5 27/32	5/8
<b>Flange rating class</b>		<b>150 x 150</b>					<b>300L x 150</b>					<b>300 x 150</b>					
<b>Valve size</b>		1 1/2 H 3					1 1/2 H 3					2 H 3					
<b>H</b>	d <sub>0</sub> [inch]	<b>1.11</b>	5 1/8	4 7/8	1 1/2	21 11/32	22 27/32	5 1/8	4 7/8	1 1/2	21 11/32	22 27/32	5 1/8	4 7/8	1 11/16	26 7/32	27 1/4
	A <sub>0</sub> [inch <sup>2</sup> ]	<b>0.975</b>	6 3/8	-	Ø 9/16	6 3/32	5/8	6 3/8	-	Ø 9/16	6 3/32	5/8	7 1/4	4 11/32	Ø 9/16	6 31/32	5/8
<b>Valve size</b>		2 J 3					2 J 3					3 J 4					
<b>J</b>	d <sub>0</sub> [inch]	<b>1.42</b>	5 3/8	4 7/8	1 15/16	26 1/2	28 7/16	5 3/8	4 7/8	1 15/16	26 1/2	28 7/16	7 1/4	7 1/8	1 15/16	30 15/16	32 7/16
	A <sub>0</sub> [inch <sup>2</sup> ]	<b>1.58</b>	7 1/4	4 11/32	Ø 9/16	7 1/4	5/8	7 1/4	4 11/32	Ø 9/16	7 1/4	5/8	9 3/8	5 1/2	Ø 23/32	9 7/32	31/32
<b>Valve size</b>		3 K 4					3 K 4					3 K 4					
<b>K</b>	WCB, LCB, d <sub>0</sub> [inch]	<b>1.69</b>	6 1/8	6 3/8	1 15/16	29 27/32	23 11/32	Please see 3 K 4					6 1/8	6 3/8	1 15/16	29 27/32	31 11/32
	CF8M (WC6) A <sub>0</sub> [inch <sup>2</sup> ]	<b>2.25</b>	9 3/8	5 1/2	Ø 23/32	8 3/32	31/32	300 x 150					9 3/8	5 1/2	Ø 23/32	8 3/32	31/32
<b>WC6</b>																	
<b>Flange rating class</b>		<b>150 x 150</b>					<b>300L x 150</b>					<b>300 x 150</b>					
<b>Valve size</b>		3 L 4					3 L 4					4 L 6					
<b>L</b>	d <sub>0</sub> [inch]	<b>2.11</b>	6 1/8	6 1/2	1 15/16	29 27/32	31 11/12	6 1/8	6 1/2	1 15/16	29 27/32	31 11/12	7 1/8	7 1/8	1 15/16	33 19/32	34 7/8
	A <sub>0</sub> [inch <sup>2</sup> ]	<b>3.48</b>	9 3/8	5 1/2	Ø 23/32	8 3/32	31/32	9 3/8	5 1/2	Ø 23/32	8 3/32	31/32	10 15/16	6 5/16	Ø 23/32	10 5/16	31/32
<b>Valve size</b>		4 M 6					4 M 6					4 M 6					
<b>M</b>	d <sub>0</sub> [inch]	<b>2.37</b>	7	7 1/4	1 7/8	33 17/32	34 27/32	Please see 4 M 6					7	7 1/4	1 7/8	33 17/32	34 27/32
	A <sub>0</sub> [inch <sup>2</sup> ]	<b>4.43</b>	10 15/16	6 5/16	Ø 23/32	10 1/4	31/32	300 x 150					10 15/16	6 5/16	Ø 23/32	10 1/4	31/32
<b>Valve size</b>		4 N 6					4 N 6					4 N 6					
<b>N</b>	d <sub>0</sub> [inch]	<b>2.60</b>	7 3/4	8 1/4	1 7/8	34 9/32	35 19/32	Please see 4 N 6					7 3/4	8 1/4	1 7/8	34 9/32	35 19/32
	A <sub>0</sub> [inch <sup>2</sup> ]	<b>5.30</b>	10 15/16	6 5/16	Ø 23/32	11	31/32	300 x 150					10 15/16	6 5/16	Ø 23/32	11	31/32
<b>Valve size</b>		4 P 6					4 P 6					4 P 6					
<b>P</b>	d <sub>0</sub> [inch]	<b>3.15</b>	7 1/8	9	1 7/8	33 31/32	34 31/32	7 1/8	9	1 7/8	33 31/32	34 31/32	8 7/8	10	2 7/16	42 1/2	44 13/16
	A <sub>0</sub> [inch <sup>2</sup> ]	<b>7.79</b>	10 15/16	6 5/16	Ø 23/32	10 5/16	31/32	10 15/16	6 5/16	Ø 23/32	10 5/16	31/32	14 9/16	8 9/32	Ø 23/32	12 1/16	31/32
<b>Valve size</b>		6 Q 8					6 Q 8					6 Q 8					
<b>Q</b>	d <sub>0</sub> [inch]	<b>4.15</b>	9 7/16	9 1/2	2 11/16	44 1/8	47 1/4	Please see 6 Q 8					9 7/16	9 1/2	2 11/16	44 1/8	47 1/4
	A <sub>0</sub> [inch <sup>2</sup> ]	<b>13.55</b>	14 9/16	8 9/32	Ø 23/32	13 5/8	31/32	300 x 150					14 9/16	8 9/32	Ø 23/32	13 5/8	31/32
<b>Valve size</b>		6 R 8					6 R 8					6 R 10					
<b>R</b>	d <sub>0</sub> [inch]	<b>4.96</b>	9 7/16	9 1/2	2 11/16	44 1/8	47 1/4	9 7/16	9 1/2	2 11/16	41 5/8	44 3/4	9 7/16	10 1/2	2 11/16	56 1/8	56 1/8
	A <sub>0</sub> [inch <sup>2</sup> ]	<b>19.33</b>	14 9/16	8 9/32	Ø 23/32	13 5/8	31/32	14 9/16	8 9/32	Ø 23/32	13 5/8	31/32	18 1/2	5 29/32	Ø 23/32	18 1/8	31/32
<b>Valve size</b>		8 T 10					8 T 10					8 T 10					
<b>T</b>	d <sub>0</sub> [inch]	<b>6.36</b>	10 7/8	11	2 7/16	57 9/16	57 9/16	Please see 8 T 10					10 7/8	11	2 7/16	57 9/16	57 9/16
	A <sub>0</sub> [inch <sup>2</sup> ]	<b>31.75</b>	18 1/2	5 29/32	Ø 23/32	19 9/16	31/32	300 x 150					18 1/2	5 29/32	Ø 23/32	19 9/16	31/32

$d_0$  = Actual orifice diameter  
 $A_0$  = Actual orifice area

a	b	s	H <sub>max.</sub>	H <sub>max.</sub> with bellows	a	b	s	H <sub>max.</sub>	H <sub>max.</sub> with bellows	a	b	s	H <sub>max.</sub>	H <sub>max.</sub> with bellows	a	b	s	H <sub>max.</sub>	H <sub>max.</sub> with bellows
A	B	C	D	E	A	B	C	D	E	A	B	C	D	E	A	B	C	D	E
<b>600 x 150</b>					<b>900 x 300</b>					<b>1500 x 300</b>					<b>2500 x 300</b>				
1 D 2					1 1/2 D 2					1 1/2 D 2					1 1/2 D 3				
4 1/8	4 1/2	1 3/16	17 5/16	18 5/16	Please see 1 1/2 D 2					4 1/8	5 1/2	1 3/4	20 11/32	21 11/32	5 1/2	7	2 1/4	22 11/16	22 11/16
5 1/8	-	Ø 9/16	5 7/32	5/8	1500 x 300					6 3/8	-	Ø 9/16	5 3/32	5/8	6 3/8	-	Ø 9/16	7 15/32	5/8
1 E 2					1 1/2 E 2					1 1/2 E 2					1 1/2 E 3				
4 1/8	4 1/2	1 3/16	17 5/16	18 5/16	Please see 1 1/2 E 2					4 1/8	5 1/2	1 3/4	20 11/32	21 11/32	5 1/2	7	2 1/4	22 11/16	22 11/16
5 1/8	-	Ø 9/16	5 7/32	5/8	1500 x 300					6 3/8	-	Ø 9/16	5 3/32	5/8	6 3/8	-	Ø 9/16	7 15/32	5/8
1 1/2 F 2					1 1/2 F 3					1 1/2 F 3					1 1/2 F 3				
4 7/8	6	1 13/32	21 3/32	22 3/32	Please see 1 1/2 F 3					4 7/8	6 1/2	1 3/4	22 1/16	22 1/16	5 1/2	7	2 1/4	22 11/16	22 11/16
6 3/8	-	Ø 9/16	5 27/32	5/8	1500 x 300					6 3/8	-	Ø 9/16	6 27/32	5/8	6 3/8	-	Ø 9/16	7 15/32	5/8
1 1/2 G 3					1 1/2 G 3					2 G 3					2 G 3				
4 7/8	6	1 13/32	21 3/32	22 19/32	4 7/8	6 1/2	1 3/4	22 1/16	22 9/16	6 1/8	6 3/4	2 11/16	27 3/32	27 3/4	6 1/8	6 3/4	2 11/16	27 3/32	27 3/4
6 3/8	-	Ø 9/16	5 27/32	5/8	6 3/8	-	Ø 14	6 27/32	5/8	7 1/4	4 11/32	Ø 9/16	7 13/16	5/8	7 1/4	4 11/32	Ø 9/16	7 13/16	5/8
<b>600 x 150</b>					<b>900 x 150</b>					<b>1500 x 300</b>									
2 H 3					2 H 3					2 H 3									
6 1/16	6 3/8	2 3/16	27 7/32	28 7/32	6 1/16	6 3/8	2 3/16	27 7/32	28 7/32	6 1/16	6 3/8	2 3/16	27 7/32	28 7/32					
7 1/4	4 11/32	Ø 9/16	7 15/16	5/8	7 1/4	4 11/32	Ø 9/16	7 15/16	5/8	7 1/4	4 11/32	Ø 9/16	7 15/16	5/8					
3 J 4					3 J 4					3 J 4									
7 1/4	7 1/8	1 15/16	30 15/16	32 7/16	7 1/4	7 1/8	2 9/16	30 15/16	32 7/16	7 1/4	7 1/8	2 3/16	30 15/16	32 7/16					
9 3/8	5 1/2	Ø 23/32	9 7/32	31/32	9 3/8	5 1/2	Ø 23/32	9 7/32	31/32	9 3/8	5 1/2	Ø 23/32	9 7/32	31/32					
3 K 4					3 K 6					3 K 6									
7 1/4	7 1/8	1 15/16	30 15/16	32 7/16	7 13/16	8 1/2	2 9/16	34 21/32	34 21/32	7 3/4	8 1/2	2 9/16	34 19/32	34 19/32					
9 3/8	5 1/2	Ø 23/32	9 7/32	31/32	10 15/16	6 5/16	Ø 23/32	11 11/32	31/32	10 15/16	6 5/16	Ø 23/32	10 15/16	31/32					
6 1/8	6 3/8	1 15/16	29 27/32	31 11/32															
9 3/8	5 1/2	Ø 23/32	8 3/32	31/32															
<b>600 x 150</b>					<b>900 x 150</b>					<b>1500 x 150</b>									
4 L 6					4 L 6					4 L 6									
7 1/16	8	2 1/4	33 19/32	34 7/8	7 3/4	8 3/4	2 3/4	34 9/32	35 19/32	7 3/4	8 3/4	2 3/4	34 9/32	35 19/32					
10 15/16	6 5/16	Ø 23/32	10 15/16	31/32	10 15/16	6 5/16	Ø 23/32	11	31/32	10 15/16	6 5/16	Ø 23/32	11	31/32					
4 M 6					4 M 6														
7	8	2 3/16	33 17/32	34 27/32	7 3/4	8 3/4	2 3/4	34 9/32	35 19/32										
10 15/16	6 5/16	Ø 23/32	10 1/4	31/32	10 15/16	6 5/16	Ø 23/32	11	31/32										
4 N 6					4 N 6														
7 3/4	8 3/4	2 3/4	34 9/32	35 19/32	7 3/4	8 3/4	2 3/4	34 9/32	35 19/32										
10 15/16	6 5/16	Ø 23/32	11	31/32	10 15/16	6 5/16	Ø 23/32	11	31/32										
4 P 6					4 P 6														
8 7/8	10	2 7/16	42 1/2	44 13/16	8 7/8	10	2 7/16	42 1/2	44 13/16										
14 9/16	8 9/32	Ø 23/32	12 1/16	31/32	14 9/16	8 9/32	Ø 23/32	12 1/16	31/32										
6 Q 8																			
9 7/16	9 1/2	2 11/16	44 1/8 <sup>1)</sup>	47 1/4 <sup>2)</sup>															
14 9/16	8 9/32	Ø 23/32	13 5/8	31/32															
6 R 10																			
9 7/16	10 1/2	2 11/16	56 1/8	56 1/8															
18 1/2	5 29/32	Ø 23/32	18 1/8	31/32															
-	-	-	-	-															
-	-	-	-	-															

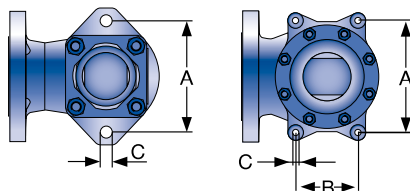

Support brackets

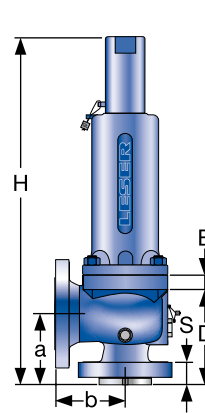

Conventional design

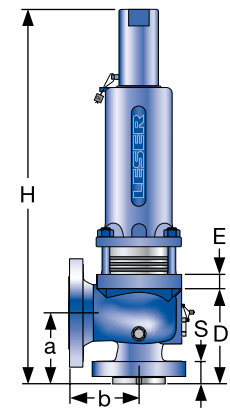

Balanced bellows design

<sup>1)</sup> Type 526 high pressure design: 47 5/16  
<sup>2)</sup> Type 526 high pressure design: 50 1/2

## Type 526

### Weighs

Metric units

		Bonnet			all			
		Lifting device			all			
Flange class		150 x 150	300L x 150	300 x 150	600 x 150	900 x 300	1500 x 300	2500 x 300
<b>Valve size</b>		1 D 2	1 D 2	1 D 2	1 D 2	1 1/2 D 2	1 1/2 D 2	1 1/2 D 3
<b>D</b>	Weight [kg]	17.3	17.3	17.3	17.3	31.1	31.1	41.8
	with bellows [kg]	18.4	18.4	18.4	18.4	33.1	33.1	44.6
<b>E</b>	Weight [kg]	17.3	17.3	17.3	17.3	31.1	31.1	41.8
	with bellows [kg]	18.4	18.4	18.4	18.4	33.1	33.1	44.6
<b>F</b>	Weight [kg]	30.6	30.6	32.5	32.5	36.3	36.3	41.8
	with bellows [kg]	33.1	33.1	35.0	35.0	38.6	38.6	44.6
<b>G</b>	Weight [kg]	30.6	30.6	32.5	32.5	36.3	69.9	69.9
	with bellows [kg]	33.1	33.1	35.0	35.0	38.6	72.5	72.5
Flange class		150 x 150	300L x 150	300 x 150	600 x 150	900 x 150	1500 x 300	
<b>Valve size</b>		1 1/2 H 3	1 1/2 H 3	2 H 3	2 H 3	2 H 3	2 H 3	
<b>H</b>	Weight [kg]	30.6	30.6	44.6	62.2	62.2	62.2	
	with bellows [kg]	33.1	33.1	48.4	65.3	65.3	65.3	
<b>J</b>	Weight [kg]	44.6	44.6	77.7	77.7	100.2	100.2	
	with bellows [kg]	48.4	48.4	83.2	83.2	105.7	105.7	
<b>K</b>	Weight [kg]	70.1	70.1	70.1	Other 77.7	WC6 70.1	127.5	127.5
	with bellows [kg]	75.7	75.7	75.7	83.2	75.7	134.1	134.1
Flange class		150 x 150	300L x 150	300 x 150	600 x 150	900 x 150	1500 x 150	
<b>Valve size</b>		3 L 4	3 L 4	4 L 6	4 L 6	4 L 6	4 L 6	
<b>L</b>	Weight [kg]	70.1	70.1	112.2	122.0	134.1	127.5	
	with bellows [kg]	75.7	75.7	118.8	128.6	140.7	134.1	
<b>M</b>	Weight [kg]	112.1	112.1	112.1	122.0	134.1		
	with bellows [kg]	118.7	118.7	118.7	128.6	140.7		
<b>N</b>	Weight [kg]	128.6	128.6	128.6	134.1	134.1		
	with bellows [kg]	135.2	135.2	135.2	140.7	140.7		
<b>P</b>	Weight [kg]	107.7	107.7	164.0	164.0	164.0		
	with bellows [kg]	114.8	114.8	172.0	172.0	172.0		
<b>Q</b>	Weight [kg]	221.0	221.0	221.0	221.0			
	with bellows [kg]	230.0	230.0	230.0	230.0			
<b>R</b>	Weight [kg]	221.0	221.0	277.0	277.0			
	with bellows [kg]	230.0	230.0	288.0	288.0			
<b>T</b>	Weight [kg]	287.0	287.0	287.0				
	with bellows [kg]	298.0	298.0	298.0				



## Type 526

### Weights

US units

		Bonnet			all			
		Lifting device			all			
Flange class		150 x 150	300L x 150	300 x 150	600 x 150	900 x 300	1500 x 300	2500 x 300
<b>Valve size</b>		1 D 2	1 D 2	1 D 2	1 D 2	1 1/2 D 2	1 1/2 D 2	1 1/2 D 3
<b>D</b>	Weight [lbs]	38.1	38.1	38.1	38.1	68.6	68.6	92.2
	with bellows [lbs]	40.6	40.6	40.6	40.6	73.0	73.0	98.3
<b>E</b>	Weight [lbs]	38.1	38.1	38.1	38.1	68.6	68.6	92.2
	with bellows [lbs]	40.6	40.6	40.6	40.6	73.0	73.0	98.3
<b>F</b>	Weight [lbs]	67.5	67.5	71.7	71.7	80.0	80.0	92.2
	with bellows [lbs]	73.0	73.0	77.2	77.2	85.1	85.1	98.3
<b>G</b>	Weight [lbs]	67.5	67.5	71.7	71.7	80.0	154.1	154.1
	with bellows [lbs]	73.0	73.0	77.2	77.2	85.0	159.9	159.9
Flange class		150 x 150	300L x 150	300 x 150	600 x 150	900 x 150	1500 x 300	
<b>Valve size</b>		1 1/2 H 3	1 1/2 H 3	2 H 3	2 H 3	2 H 3	2 H 3	
<b>H</b>	Weight [lbs]	67.5	67.5	98.3	137.2	137.2	137.2	
	with bellows [lbs]	73.0	73.0	106.7	144.0	144.0	144.0	
<b>J</b>	Weight [lbs]	98.3	98.3	171.3	171.3	220.9	220.9	
	with bellows [lbs]	106.7	106.7	183.5	183.5	233.1	233.1	
<b>K</b>	Weight [lbs]	154.6	154.6	154.6	Other 171.3	WC6 154.6	281.1	281.1
	with bellows [lbs]	166.9	166.9	166.9	183.5	166.9	295.7	295.7
Flange class		150 x 150	300L x 150	300 x 150	600 x 150	900 x 150	1500 x 150	
<b>Valve size</b>		3 L 4	3 L 4	4 L 6	4 L 6	4 L 6	4 L 6	
<b>L</b>	Weight [lbs]	154.6	154.6	247.4	269.0	295.7	281.1	
	with bellows [lbs]	166.9	166.9	262.0	283.6	310.2	295.7	
<b>M</b>	Weight [lbs]	247.2	247.2	247.2	269.0	295.7		
	with bellows [lbs]	261.7	261.7	261.7	283.6	310.2		
<b>N</b>	Weight [lbs]	283.6	283.6	283.6	295.7	295.7		
	with bellows [lbs]	298.1	298.1	298.1	310.2	310.2		
<b>P</b>	Weight [lbs]	237.5	237.5	361.6	361.6	361.6		
	with bellows [lbs]	253.1	253.1	379.2	379.2	379.2		
<b>Q</b>	Weight [lbs]	487.3	487.3	487.3	487.3			
	with bellows [lbs]	507.2	507.2	507.2	507.2			
<b>R</b>	Weight [lbs]	487.3	487.3	610.8	610.8			
	with bellows [lbs]	507.2	507.2	635.0	635.0			
<b>T</b>	Weight [lbs]	632.8	632.8	632.8				
	with bellows [lbs]	657.1	657.1	657.1				

## Type 526

### Orifice D

#### Pressure temperature ratings

#### Metric units

Valve size	1 D 2	1 D 2	1 D 2	1 D 2	1 1/2 D 2	1 1/2 D 2	1 1/2 D 3	
Flange rating class <small>Inlet x Outlet</small>	150 x 150	300L x 150	300 x 150	600 x 150	900 x 300	1500 x 300	2500 x 300	
Actual Orifice diameter $d_o$ [mm]	14.0	14.0	14.0	14.0	14.0	14.0	14.0	
Actual Orifice area $A_o$ [mm <sup>2</sup> ]	154	154	154	154	154	154	154	
Minimum set pressure [bar] S/G/L	0.3	0.3	0.3	0.3	5.0	5.0	18.5	
Minimum set pressure [bar] S/G	3.5	3.5	3.5	11.0	24.0	24.0	24.0	
Balanced bellows Inconel [bar] L	3.5	3.5	3.5	11.0	11.0	11.0	11.0	
<b>Body material: WCB 1.0619</b>		<b>Pressure range p [bar] S/G/L</b>						
<b>Article numbers</b>	<b>5262.001<sup>o</sup></b>	Use 1 D 2 300 x 150	<b>5262.002<sup>o</sup></b>	<b>5262.003<sup>o</sup></b>	Use 1 1/2 D 2 1500 x 300	<b>5262.004<sup>o</sup></b>	<b>5262.005<sup>o</sup></b>	
<b>Maximum set pressure</b>	-29 to 38 °C		19.7	51.0		102.1	255.5	413.8
	232 °C		12.8	42.4		85.2	212.4	354.1
	427 °C		5.5	28.3		56.9	142.1	236.6
<b>Outlet pressure limit</b> Conventional design			19.7	19.7		19.7	41.4	51.0
<b>Outlet pressure limit</b> Balanced bellows design		15.9	15.9	15.9	34.5	34.5		
<b>Body material: CF8M 1.4408</b>		<b>Pressure range p [bar] S/G/L</b>						
<b>Article numbers</b>	<b>5264.010<sup>o</sup></b>	Use 1 D 2 300 x 150	<b>5264.011<sup>o</sup></b>	<b>5264.012<sup>o</sup></b>	Use 1 1/2 D 2 1500 x 300	<b>5264.013<sup>o</sup></b>	<b>5264.014<sup>o</sup></b>	
<b>Maximum set pressure</b>	-268 to -60 °C		19.0	49.7		99.3	248.3	275.9
	-59 to -29 °C		19.0	49.7		99.3	248.3	413.8
	-28 to 38 °C		19.0	49.7		99.3	248.3	413.8
	232 °C		12.4	34.1		67.2	171.0	284.8
	427 °C		5.5	29.0		58.3	145.5	242.8
	538 °C	1.4	24.1	48.3	120.7	201.0		
<b>Outlet pressure limit</b> Conventional design		19.0	19.0	19.0	41.4	49.7		
<b>Outlet pressure limit</b> Balanced bellows design		15.9	15.9	15.9	34.5	34.5		
<b>Body material: WC6 1.7357</b>		<b>Pressure range p [bar] S/G/L</b>						
<b>Article numbers</b>	-	Use 1 D 2 300 x 150	<b>5267.006<sup>o</sup></b>	<b>5267.007<sup>o</sup></b>	Use 1 1/2 D 2 1500 x 300	<b>5267.008<sup>o</sup></b>	<b>5267.009<sup>o</sup></b>	
<b>Maximum set pressure</b>	427 °C		-	35.2		70.0	175.2	291.7
	538 °C		-	14.8		29.7	74.5	124.1
<b>Outlet pressure limit</b> Conventional design			-	19.7		19.7	41.4	51.0
<b>Outlet pressure limit</b> Balanced bellows design		-	15.9	15.9	34.5	34.5		
<b>Body material: LCB</b>		<b>Pressure range p [bar] S/G/L</b>						
<b>Article numbers</b>	<b>5263.500<sup>o</sup></b>	Use 1 D 2 300 x 150	<b>5263.501<sup>o</sup></b>	<b>5263.502<sup>o</sup></b>	Use 1 1/2 D 2 1500 x 300	<b>5263.503<sup>o</sup></b>	<b>5263.504<sup>o</sup></b>	
<b>Maximum set pressure</b>	-46 to 38 °C		18.4	48.0		96.0	240.1	400.1
	200 °C		13.8	42.5		85.1	212.7	354.4
	343 °C		8.4	36.4		72.8	182.0	303.3
<b>Outlet pressure limit</b> Conventional design		18.4	18.4	18.4	41.4	48.0		
<b>Outlet pressure limit</b> Balanced bellows design		15.9	15.9	15.9	34.5	34.5		

<sup>o</sup> Please add code for the required cap or lifting device. See page 11.

Remark: SA 352 Gr. LCB is not listed in the API 526. Pressure-Temperature Rating acc. to ASME B16.34 Table 2-1.3  
The stated Pressure-Temperature Rating are taken from ASME B16.34 Table 2-1.3 if the maximum pressure is not limited by API 526.

Due to the extended material test certificate the LESER LCB can be applied as LCC, WCB, WCC and 1.0619 with the respective pressure-temperature range as well.

## Type 526

### Orifice D

#### Pressure temperature ratings

#### US units

Valve size	1 D 2	1 D 2	1 D 2	1 D 2	1 1/2 D 2	1 1/2 D 2	1 1/2 D 3	
Flange rating class <small>Inlet x Outlet</small>	150 x 150	300L x 150	300 x 150	600 x 150	900 x 300	1500 x 300	2500 x 300	
Actual Orifice diameter $d_0$ [inch]	0.551	0.551	0.551	0.551	0.551	0.551	0.551	
Actual Orifice area $A_0$ [inch <sup>2</sup> ]	0.239	0.239	0.239	0.239	0.239	0.239	0.239	
Minimum set pressure [psig] S/G/L	4.0	4.0	4.0	4.0	73.0	73.0	268.0	
Minimum set pressure [psig] S/G	50.8	50.8	50.8	159.5	348.0	348.0	348.0	
Balanced bellows Inconel [psig] L	50.8	50.8	50.8	159.5	159.5	159.5	159.5	
<b>Body material: WCB 1.0619</b>		<b>Pressure range p [psig] S/G/L</b>						
<b>Article numbers</b>	<b>5262.001<sup>a</sup></b>	Use 1 D 2 300 x 150	<b>5262.002<sup>a</sup></b>	<b>5262.003<sup>a</sup></b>	Use 1 1/2 D 2 1500 x 300	<b>5262.004<sup>a</sup></b>	<b>5262.005<sup>a</sup></b>	
<b>Maximum set pressure</b>	-20 to 100 °F		285	740		1480	3705	6000
	450 °F		185	615		1235	3080	5135
	800 °F		80	410		825	2060	3430
<b>Outlet pressure limit</b> Conventional design			285	285		285	600	740
<b>Outlet pressure limit</b> Balanced bellows design		230	230	230	500	500		
<b>Body material: CF8M 1.4408</b>		<b>Pressure range p [psig] S/G/L</b>						
<b>Article numbers</b>	<b>5264.010<sup>a</sup></b>	Use 1 D 2 300 x 150	<b>5264.011<sup>a</sup></b>	<b>5264.012<sup>a</sup></b>	Use 1 1/2 D 2 1500 x 300	<b>5264.013<sup>a</sup></b>	<b>5264.014<sup>a</sup></b>	
<b>Maximum set pressure</b>	-450 to -76 °F		275	720		1440	3600	4000
	-75 to -21 °F		275	720		1440	3600	6000
	-20 to 100 °F		275	720		1440	3600	6000
	450 °F		180	495		975	2480	4130
	800 °F		80	420		845	2110	3520
	1000 °F		20	350		700	1750	2915
<b>Outlet pressure limit</b> Conventional design		275	275	275	600	720		
<b>Outlet pressure limit</b> Balanced bellows design		230	230	230	500	500		
<b>Body material: WC6 1.7357</b>		<b>Pressure range p [psig] S/G/L</b>						
<b>Article numbers</b>	<b>–</b>	Use 1 D 2 300 x 150	<b>5267.006<sup>a</sup></b>	<b>5267.007<sup>a</sup></b>	Use 1 1/2 D 2 1500 x 300	<b>5267.008<sup>a</sup></b>	<b>5267.009<sup>a</sup></b>	
<b>Maximum set pressure</b>	800 °F		–	510		1015	2540	4230
	1000 °F		–	215		430	1080	1800
<b>Outlet pressure limit</b> Conventional design			–	285		285	600	740
<b>Outlet pressure limit</b> Balanced bellows design		–	230	230	500	500		
<b>Body material: LCB</b>		<b>Pressure range p [psig] S/G/L</b>						
<b>Article numbers</b>	<b>5263.500<sup>a</sup></b>	Use 1 D 2 300 x 150	<b>5263.501<sup>a</sup></b>	<b>5263.502<sup>a</sup></b>	Use 1 1/2 D 2 1500 x 300	<b>5263.503<sup>a</sup></b>	<b>5263.504<sup>a</sup></b>	
<b>Maximum set pressure</b>	-50 to 100 °F		265	695		1395	3480	5805
	400 °F		200	615		1230	3075	5125
	650 °F		125	535		1065	2665	4440
<b>Outlet pressure limit</b> Conventional design			265	265		265	600	695
<b>Outlet pressure limit</b> Balanced bellows design		230	230	230	500	500		

<sup>a)</sup> Please add code for the required cap or lifting device. See page 11.

Remark: SA 352 Gr. LCB is not listed in the API 526. Pressure-Temperature Rating acc. to ASME B16.34 Table 2-1.3  
The stated Pressure-Temperature Rating are taken from ASME B16.34 Table 2-1.3 if the maximum pressure is not limited by API 526.

Due to the extended material test certificate the LESER LCB can be applied as LCC, WCB, WCC and 1.0619 with the respective pressure-temperature range as well.

## Type 526

### Orifice E

#### Pressure temperature ratings

#### Metric units

Valve size	1 E 2	1 E 2	1 E 2	1 E 2	1 1/2 E 2	1 1/2 E 2	1 1/2 E 3	
Flange rating class <small>Inlet x Outlet</small>	150 x 150	300L x 150	300 x 150	600 x 150	900 x 300	1500 x 300	2500 x 300	
Actual Orifice diameter $d_o$ [mm]	14.0	14.0	14.0	14.0	14.0	14.0	14.0	
Actual Orifice area $A_o$ [mm <sup>2</sup> ]	154	154	154	154	154	154	154	
Minimum set pressure [bar] S/G/L	0.3	0.3	0.3	0.3	5.0	5.0	18.5	
Minimum set pressure [bar] S/G	3.5	3.5	3.5	11.0	24.0	24.0	24.0	
Balanced bellows Inconel [bar] L	3.5	3.5	3.5	11.0	11.0	11.0	11.0	
<b>Body material: WCB 1.0619</b>								
<b>Pressure range p [bar] S/G/L</b>								
<b>Article numbers</b>	<b>5262.015<sup>o</sup></b>	Use 1 E 2 300 x 150	<b>5262.016<sup>o</sup></b>	<b>5262.017<sup>o</sup></b>	Use 1 1/2 E 2 1500 x 300	<b>5262.018<sup>o</sup></b>	<b>5262.019<sup>o</sup></b>	
<b>Maximum set pressure</b>	-29 to 38 °C		19.7	51.0		102.1	255.5	413.8
	232 °C		12.8	42.4		85.2	212.4	354.1
	427 °C		5.5	28.3		56.9	142.1	236.6
<b>Outlet pressure limit</b> Conventional design			19.7	19.7		19.7	41.4	51.0
<b>Outlet pressure limit</b> Balanced bellows design		15.9	15.9	15.9	34.5	34.5		
<b>Body material: CF8M 1.4408</b>								
<b>Pressure range p [bar] S/G/L</b>								
<b>Article numbers</b>	<b>5264.024<sup>o</sup></b>	Use 1 E 2 300 x 150	<b>5264.025<sup>o</sup></b>	<b>5264.026<sup>o</sup></b>	Use 1 1/2 E 2 1500 x 300	<b>5264.027<sup>o</sup></b>	<b>5264.028<sup>o</sup></b>	
<b>Maximum set pressure</b>	-268 to -60 °C		19.0	49.7		99.3	248.3	275.9
	-59 to -29 °C		19.0	49.7		99.3	248.3	413.8
	-28 to 38 °C		19.0	49.7		99.3	248.3	413.8
	232 °C		12.4	34.1		67.2	171.0	284.8
	427 °C		5.5	29.0		58.3	145.5	242.8
	538 °C	1.4	24.1	48.3	120.7	201.0		
<b>Outlet pressure limit</b> Conventional design		19.0	19.0	19.0	41.4	49.7		
<b>Outlet pressure limit</b> Balanced bellows design		15.9	15.9	15.9	34.5	34.5		
<b>Body material: WC6 1.7357</b>								
<b>Pressure range p [bar] S/G/L</b>								
<b>Article numbers</b>	-	Use 1 E 2 300 x 150	<b>5267.020<sup>o</sup></b>	<b>5267.021<sup>o</sup></b>	Use 1 1/2 E 2 1500 x 300	<b>5267.022<sup>o</sup></b>	<b>5267.023<sup>o</sup></b>	
<b>Maximum set pressure</b>	427 °C		-	35.2		70.0	175.2	291.7
	538 °C		-	14.8		29.7	74.5	124.1
<b>Outlet pressure limit</b> Conventional design			-	19.7		19.7	41.4	51.0
<b>Outlet pressure limit</b> Balanced bellows design		-	15.9	15.9	34.5	34.5		
<b>Body material: LCB</b>								
<b>Pressure range p [bar] S/G/L</b>								
<b>Article numbers</b>	<b>5263.505<sup>o</sup></b>	Use 1 E 2 300 x 150	<b>5263.506<sup>o</sup></b>	<b>5263.507<sup>o</sup></b>	Use 1 1/2 E 2 1500 x 300	<b>5263.508<sup>o</sup></b>	<b>5263.509<sup>o</sup></b>	
<b>Maximum set pressure</b>	-46 to 38 °C		18.4	48.0		96.0	240.1	400.1
	200 °C		13.8	42.5		85.1	212.7	354.4
	343 °C		8.4	36.4		72.8	182.0	303.3
<b>Outlet pressure limit</b> Conventional design		18.4	18.4	18.4	41.4	48.0		
<b>Outlet pressure limit</b> Balanced bellows design		15.9	15.9	15.9	34.5	34.5		

<sup>o</sup> Please add code for the required cap or lifting device. See page 11.

Remark: SA 352 Gr. LCB is not listed in the API 526. Pressure-Temperature Rating acc. to ASME B16.34 Table 2-1.3  
The stated Pressure-Temperature Rating are taken from ASME B16.34 Table 2-1.3 if the maximum pressure is not limited by API 526.

Due to the extended material test certificate the LESER LCB can be applied as LCC, WCB, WCC and 1.0619 with the respective pressure-temperature range as well.

## Type 526

### Orifice E

#### Pressure temperature ratings

#### US units

Valve size	1 E 2	1 E 2	1 E 2	1 E 2	1 1/2 E 2	1 1/2 E 2	1 1/2 E 3	
Flange rating class <small>Inlet x Outlet</small>	150 x 150	300L x 150	300 x 150	600 x 150	900 x 300	1500 x 300	2500 x 300	
Actual Orifice diameter $d_0$ [inch]	0.551	0.551	0.551	0.551	0.551	0.551	0.551	
Actual Orifice area $A_0$ [inch <sup>2</sup> ]	0.239	0.239	0.239	0.239	0.239	0.239	0.239	
Minimum set pressure [psig] S/G/L	4.0	4.0	4.0	4.0	73.0	73.0	268.0	
Minimum set pressure [psig] S/G	50.8	50.8	50.8	159.5	348.0	348.0	348.0	
Balanced bellows Inconel [psig] L	50.8	50.8	50.8	159.5	159.5	159.5	159.5	
<b>Body material: WCB 1.0619</b>		<b>Pressure range p [psig] S/G/L</b>						
<b>Article numbers</b>	<b>5262.015<sup>a)</sup></b>	Use 1 E 2 300 x 150	<b>5262.016<sup>a)</sup></b>	<b>5262.017<sup>a)</sup></b>	Use 1 1/2 E 2 1500 x 300	<b>5262.018<sup>a)</sup></b>	<b>5262.019<sup>a)</sup></b>	
<b>Maximum set pressure</b>	-20 to 100 °F		285	740		1480	3705	6000
	450 °F		185	615		1235	3080	5135
	800 °F		80	410		825	2060	3430
<b>Outlet pressure limit</b>	Conventional design		285	285		285	600	740
	Balanced bellows design	230	230	230	500	500		
<b>Body material: CF8M 1.4408</b>		<b>Pressure range p [psig] S/G/L</b>						
<b>Article numbers</b>	<b>5264.024<sup>a)</sup></b>	Use 1 E 2 300 x 150	<b>5264.025<sup>a)</sup></b>	<b>5264.026<sup>a)</sup></b>	Use 1 1/2 E 2 1500 x 300	<b>5264.027<sup>a)</sup></b>	<b>5264.028<sup>a)</sup></b>	
<b>Maximum set pressure</b>	-450 to -76 °F		275	720		1440	3600	4000
	-75 to -21 °F		275	720		1440	3600	6000
	-20 to 100 °F		275	720		1440	3600	6000
	450 °F		180	495		975	2480	4130
	800 °F		80	420		845	2110	3520
	1000 °F		20	350		700	1750	2915
<b>Outlet pressure limit</b>	Conventional design	275	275	275	600	720		
	Balanced bellows design	230	230	230	500	500		
<b>Body material: WC6 1.7357</b>		<b>Pressure range p [psig] S/G/L</b>						
<b>Article numbers</b>	-	Use 1 E 2 300 x 150	<b>5267.020<sup>a)</sup></b>	<b>5267.021<sup>a)</sup></b>	Use 1 1/2 E 2 1500 x 300	<b>5267.022<sup>a)</sup></b>	<b>5267.023<sup>a)</sup></b>	
<b>Maximum set pressure</b>	800 °F		-	510		1015	2540	4230
	1000 °F		-	215		430	1080	1800
<b>Outlet pressure limit</b>	Conventional design		-	285		285	600	740
	Balanced bellows design		-	230		230	500	500
<b>Body material: LCB</b>		<b>Pressure range p [psig] S/G/L</b>						
<b>Article numbers</b>	<b>5263.505<sup>a)</sup></b>	Use 1 E 2 300 x 150	<b>5263.506<sup>a)</sup></b>	<b>5263.507<sup>a)</sup></b>	Use 1 1/2 E 2 1500 x 300	<b>5263.508<sup>a)</sup></b>	<b>5263.509<sup>a)</sup></b>	
<b>Maximum set pressure</b>	-50 to 100 °F		265	695		1395	3480	5805
	400 °F		200	615		1230	3075	5125
	650 °F		125	535		1065	2665	4440
<b>Outlet pressure limit</b>	Conventional design		265	265		265	600	695
	Balanced bellows design	230	230	230	500	500		

<sup>a)</sup> Please add code for the required cap or lifting device. See page 11.

Remark: SA 352 Gr. LCB is not listed in the API 526. Pressure-Temperature Rating acc. to ASME B16.34 Table 2-1.3  
The stated Pressure-Temperature Rating are taken from ASME B16.34 Table 2-1.3 if the maximum pressure is not limited by API 526.

Due to the extended material test certificate the LESER LCB can be applied as LCC, WCB, WCC and 1.0619 with the respective pressure-temperature range as well.

## Type 526

### Orifice F

#### Pressure temperature ratings

#### Metric units

Valve size	1 1/2 F 2	1 1/2 F 2	1 1/2 F 2	1 1/2 F 2	1 1/2 F 3	1 1/2 F 3	1 1/2 F 3	
Flange rating class <small>Inlet x Outlet</small>	150 x 150	300L x 150	300 x 150	600 x 150	900 x 300	1500 x 300	2500 x 300	
Actual Orifice diameter $d_o$ [mm]	18.0	18.0	18.0	18.0	18.0	18.0	18.0	
Actual Orifice area $A_o$ [mm <sup>2</sup> ]	254	254	254	254	254	254	254	
Minimum set pressure [bar] S/G/L	0.3	0.3	0.3	0.3	0.3	0.3	0.3	
Minimum set pressure [bar] S/G	1.7	1.7	1.7	12.0	12.0	12.0	13.5	
Balanced bellows Inconel [bar] L	2.5	2.5	2.5	8.2	8.2	8.2	8.2	
<b>Body material: WCB 1.0619</b>								
<b>Pressure range p [bar] S/G/L</b>								
<b>Article numbers</b>	<b>5262.029<sup>o</sup></b>	<b>5262.030<sup>o</sup></b>	<b>5262.031<sup>o</sup></b>	<b>5262.032<sup>o</sup></b>	Use 1 1/2 F 3 1500 x 300	<b>5262.033<sup>o</sup></b>	<b>5262.034<sup>o</sup></b>	
<b>Maximum set pressure</b>	-29 to 38 °C	19.7	19.7	51.0		102.1	255.5	344.8
	232 °C	12.8	19.7	42.4		85.2	212.4	344.8
	427 °C	5.5	19.7	28.3		56.9	142.1	236.6
<b>Outlet pressure limit</b>	Conventional design	19.7	19.7	19.7		19.7	51.0	51.0
<b>Outlet pressure limit</b>	Balanced bellows design	15.9	15.9	15.9	15.9	34.5	34.5	
<b>Body material: CF8M 1.4408</b>								
<b>Pressure range p [bar] S/G/L</b>								
<b>Article numbers</b>	<b>5264.039<sup>o</sup></b>	<b>5264.040<sup>o</sup></b>	<b>5264.041<sup>o</sup></b>	<b>5264.042<sup>o</sup></b>	Use 1 1/2 F 3 1500 x 300	<b>5264.043<sup>o</sup></b>	<b>5264.044<sup>o</sup></b>	
<b>Maximum set pressure</b>	-268 to -60 °C	19.0	19.0	49.7		99.3	151.7	234.5
	-59 to -29 °C	19.0	19.0	49.7		99.3	248.3	344.8
	-28 to 38 °C	19.0	19.0	49.7		99.3	248.3	344.8
	232 °C	12.4	19.0	34.1		67.2	171.0	284.8
	427 °C	5.5	19.0	29.0		58.3	145.5	242.8
	538 °C	1.4	19.0	24.1	48.3	120.7	201.0	
<b>Outlet pressure limit</b>	Conventional design	19.0	19.0	19.0	19.0	49.7	49.7	
<b>Outlet pressure limit</b>	Balanced bellows design	15.9	15.9	15.9	15.9	34.5	34.5	
<b>Body material: WC6 1.7357</b>								
<b>Pressure range p [bar] S/G/L</b>								
<b>Article numbers</b>	-	-	<b>5267.035<sup>o</sup></b>	<b>5267.036<sup>o</sup></b>	Use 1 1/2 F 3 1500 x 300	<b>5267.037<sup>o</sup></b>	<b>5267.038<sup>o</sup></b>	
<b>Maximum set pressure</b>	427 °C	-	35.2	70.0		175.2	291.7	
	538 °C	-	14.8	29.7		74.5	124.1	
<b>Outlet pressure limit</b>	Conventional design	-	19.7	19.7		51.0	51.0	
<b>Outlet pressure limit</b>	Balanced bellows design	-	15.9	15.9	34.5	34.5		
<b>Body material: LCB</b>								
<b>Pressure range p [bar] S/G/L</b>								
<b>Article numbers</b>	<b>5263.510<sup>o</sup></b>	<b>5263.511<sup>o</sup></b>	<b>5263.512<sup>o</sup></b>	<b>5263.513<sup>o</sup></b>	Use 1 1/2 F 3 1500 x 300	<b>5263.514<sup>o</sup></b>	<b>5263.515<sup>o</sup></b>	
<b>Maximum set pressure</b>	-46 to 38 °C	18.4	18.4	48.0		96.0	240.1	344.8
	200 °C	13.8	18.4	42.5		85.1	212.7	344.8
	343 °C	8.4	18.4	36.4		72.8	182.0	303.3
<b>Outlet pressure limit</b>	Conventional design	18.4	18.4	18.4		18.4	48.0	48.0
<b>Outlet pressure limit</b>	Balanced bellows design	15.9	15.9	15.9	15.9	34.5	34.5	

<sup>o</sup> Please add code for the required cap or lifting device. See page 11.

Remark: SA 352 Gr. LCB is not listed in the API 526. Pressure-Temperature Rating acc. to ASME B16.34 Table 2-1.3  
The stated Pressure-Temperature Rating are taken from ASME B16.34 Table 2-1.3 if the maximum pressure is not limited by API 526.

Due to the extended material test certificate the LESER LCB can be applied as LCC, WCB, WCC and 1.0619 with the respective pressure-temperature range as well.

## Type 526

### Orifice F

Pressure temperature ratings

US units

Valve size	1 1/2 F 2	1 1/2 F 2	1 1/2 F 2	1 1/2 F 2	1 1/2 F 3	1 1/2 F 3	1 1/2 F 3	
F Flange rating class <small>Inlet x Outlet</small>	150 x 150	300L x 150	300 x 150	600 x 150	900 x 300	1500 x 300	2500 x 300	
Actual Orifice diameter $d_0$ [inch]	0.709	0.709	0.709	0.709	0.709	0.709	0.709	
Actual Orifice area $A_0$ [inch <sup>2</sup> ]	0.394	0.394	0.394	0.394	0.394	0.394	0.394	
Minimum set pressure [psig] S/G/L	4.0	4.0	4.0	4.0	4.0	4.0	4.0	
Minimum set pressure [psig] S/G	24.6	24.6	24.6	174.0	174.0	174.0	159.0	
Balanced bellows Inconel [psig] L	36.3	36.3	36.3	118.9	118.9	118.9	118.9	
<b>Body material: WCB 1.0619</b>								
<b>Pressure range p [psig] S/G/L</b>								
<b>Article numbers</b>	<b>5262.029<sup>o</sup></b>	<b>5262.030<sup>o</sup></b>	<b>5262.031<sup>o</sup></b>	<b>5262.032<sup>o</sup></b>	Use 1 1/2 F 3 1500 x 300	<b>5262.033<sup>o</sup></b>	<b>5262.034<sup>o</sup></b>	
<b>Maximum set pressure</b>	-20 to 100 °F	285	285	740		1480	3705	5000
	450 °F	185	285	615		1235	3080	5000
	800 °F	80	285	410		825	2060	3430
<b>Outlet pressure limit</b> Conventional design		285	285	285		285	740	740
<b>Outlet pressure limit</b> Balanced bellows design		230	230	230	230	500	500	
<b>Body material: CF8M 1.4408</b>								
<b>Pressure range p [psig] S/G/L</b>								
<b>Article numbers</b>	<b>5264.039<sup>o</sup></b>	<b>5264.040<sup>o</sup></b>	<b>5264.041<sup>o</sup></b>	<b>5264.042<sup>o</sup></b>	Use 1 1/2 F 3 1500 x 300	<b>5264.043<sup>o</sup></b>	<b>5264.044<sup>o</sup></b>	
<b>Maximum set pressure</b>	-450 to -76 °F	275	275	720		1440	2200	3400
	-75 to -21 °F	275	275	720		1440	3600	5000
	-20 to 100 °F	275	275	720		1440	3600	5000
	450 °F	180	275	495		975	2480	4130
	800 °F	80	275	420		845	2110	3520
1000 °F	20	275	350	700		1750	2915	
<b>Outlet pressure limit</b> Conventional design		275	275	275	275	720	720	
<b>Outlet pressure limit</b> Balanced bellows design		230	230	230	230	500	500	
<b>Body material: WC6 1.7357</b>								
<b>Pressure range p [psig] S/G/L</b>								
<b>Article numbers</b>	-	-	<b>5267.035<sup>o</sup></b>	<b>5267.036<sup>o</sup></b>	Use 1 1/2 F 3 1500 x 300	<b>5267.037<sup>o</sup></b>	<b>5267.038<sup>o</sup></b>	
<b>Maximum set pressure</b>	800 °F	-	510	1015		2540	4230	
	1000 °F	-	215	430		1080	1800	
<b>Outlet pressure limit</b> Conventional design		-	285	285		740	740	
<b>Outlet pressure limit</b> Balanced bellows design		-	230	230	500	500		
<b>Body material: LCB</b>								
<b>Pressure range p [psig] S/G/L</b>								
<b>Article numbers</b>	<b>5263.510<sup>o</sup></b>	<b>5263.511<sup>o</sup></b>	<b>5263.512<sup>o</sup></b>	<b>5263.513<sup>o</sup></b>	Use 1 1/2 F 3 1500 x 300	<b>5263.514<sup>o</sup></b>	<b>5263.515<sup>o</sup></b>	
<b>Maximum set pressure</b>	-50 to 100 °F	265	265	695		1395	3480	5000
	400 °F	200	265	615		1230	3075	5000
	650 °F	125	265	535		1065	2665	4440
<b>Outlet pressure limit</b> Conventional design		265	265	265		265	695	695
<b>Outlet pressure limit</b> Balanced bellows design		230	230	230	230	500	500	

<sup>o</sup>) Please add code for the required cap or lifting device. See page 11.

Remark: SA 352 Gr. LCB is not listed in the API 526. Pressure-Temperature Rating acc. to ASME B16.34 Table 2-1.3  
The stated Pressure-Temperature Rating are taken from ASME B16.34 Table 2-1.3 if the maximum pressure is not limited by API 526.

Due to the extended material test certificate the LESER LCB can be applied as LCC, WCB, WCC and 1.0619 with the respective pressure-temperature range as well.

## Type 526

### Orifice G

#### Pressure temperature ratings

#### Metric units

Valve size	1 1/2 G 3	1 1/2 G 3	1 1/2 G 3	1 1/2 G 3	1 1/2 G 3	2 G 3	2 G 3
Flange rating class <small>Inlet x Outlet</small>	150 x 150	300L x 150	300 x 150	600 x 150	900 x 300	1500 x 300	2500 x 300
Actual Orifice diameter $d_o$ [mm]	22.5	22.5	22.5	22.5	22.5	22.5	22.5
Actual Orifice area $A_o$ [mm <sup>2</sup> ]	398	398	398	398	398	398	398
Minimum set pressure [bar] S/G/L	0.2 <sup>1)</sup>	0.2 <sup>1)</sup>	0.2 <sup>1)</sup>	0.2 <sup>1)</sup>	0.2 <sup>1)</sup>	5.0	5.0
Minimum set pressure [bar] S/G	3.4	3.4	3.4	9.2	9.2	9.2	9.2
Balanced bellows Inconel [bar] L	3.2	3.2	3.2	18.5	18.5	18.5	18.5
<b>Body material: WCB 1.0619</b>							
<b>Pressure range p [bar] S/G/L</b>							
<b>Article numbers</b>	<b>5262.045<sup>o)</sup></b>	<b>5262.046<sup>o)</sup></b>	<b>5262.047<sup>o)</sup></b>	<b>5262.048<sup>o)</sup></b>	<b>5262.049<sup>o)</sup></b>	<b>5262.050<sup>o)</sup></b>	<b>5262.051<sup>o)</sup></b>
<b>Maximum set pressure</b>	-29 to 38 °C	19.7	19.7	51.0	102.1	153.1	255.5
	232 °C	12.8	19.7	42.4	85.2	127.2	255.5
	427 °C	5.5	19.7	28.3	56.9	85.2	236.6
<b>Outlet pressure limit</b> Conventional design	19.7	19.7	19.7	19.7	51.0	51.0	51.0
<b>Outlet pressure limit</b> Balanced bellows design	15.9	15.9	15.9	15.9	32.4	32.4	32.4
<b>Body material: CF8M 1.4408</b>							
<b>Pressure range p [bar] S/G/L</b>							
<b>Article numbers</b>	<b>5264.110<sup>o)</sup></b>	<b>5264.111<sup>o)</sup></b>	<b>5264.112<sup>o)</sup></b>	<b>5264.113<sup>o)</sup></b>	<b>5264.114<sup>o)</sup></b>	<b>5264.115<sup>o)</sup></b>	<b>5264.116<sup>o)</sup></b>
<b>Maximum set pressure</b>	-268 to -60 °C	19.0	19.0	49.7	99.3	149.0	179.3
	-59 to -29 °C	19.0	19.0	49.7	99.3	149.0	255.5
	-28 to 38 °C	19.0	19.0	49.7	99.3	149.0	255.5
	232 °C	12.4	19.0	34.1	67.2	102.4	255.5
	427 °C	5.5	19.0	29.0	58.3	87.2	242.8
538 °C	1.4	19.0	24.1	48.3	72.4	201.0	
<b>Outlet pressure limit</b> Conventional design	19.0	19.0	19.0	19.0	49.7	49.7	49.7
<b>Outlet pressure limit</b> Balanced bellows design	15.9	15.9	15.9	15.9	32.4	32.4	32.4
<b>Body material: WC6 1.7357</b>							
<b>Pressure range p [bar] S/G/L</b>							
<b>Article numbers</b>	–	–	<b>5267.052<sup>o)</sup></b>	<b>5267.053<sup>o)</sup></b>	<b>5267.054<sup>o)</sup></b>	<b>5267.055<sup>o)</sup></b>	<b>5267.056<sup>o)</sup></b>
<b>Maximum set pressure</b>	427 °C	–	35.2	70.0	105.2	175.2	255.5
	538 °C	–	14.8	29.7	44.8	74.5	124.1
<b>Outlet pressure limit</b> Conventional design	–	–	19.7	19.7	51.0	51.0	51.0
<b>Outlet pressure limit</b> Balanced bellows design	–	–	15.9	15.9	32.4	32.4	32.4
<b>Body material: LCB</b>							
<b>Pressure range p [bar] S/G/L</b>							
<b>Article numbers</b>	<b>5263.516<sup>o)</sup></b>	<b>5263.517<sup>o)</sup></b>	<b>5263.518<sup>o)</sup></b>	<b>5263.519<sup>o)</sup></b>	<b>5263.520<sup>o)</sup></b>	<b>5263.521<sup>o)</sup></b>	<b>5263.522<sup>o)</sup></b>
<b>Maximum set pressure</b>	-46 to 38 °C	18.4	18.4	48.0	96.0	144.1	255.5
	200 °C	13.8	18.4	42.5	85.1	127.6	255.5
	343 °C	8.4	18.4	36.4	72.8	109.2	255.5
<b>Outlet pressure limit</b> Conventional design	18.4	18.4	18.4	18.4	48.0	48.0	48.0
<b>Outlet pressure limit</b> Balanced bellows design	15.9	15.9	15.9	15.9	32.4	32.4	32.4

<sup>o)</sup> Please add code for the required cap or lifting device. See page 11.

Remark: SA 352 Gr. LCB is not listed in the API 526. Pressure-Temperature Rating acc. to ASME B16.34 Table 2-1.3  
The stated Pressure-Temperature Rating are taken from ASME B16.34 Table 2-1.3 if the maximum pressure is not limited by API 526.

Due to the extended material test certificate the LESER LCB can be applied as LCC, WCB, WCC and 1.0619 with the respective pressure-temperature range as well.

<sup>1)</sup> The pressure range 0.2 – 2.5 bar is outside of the type test approval acc. to ISO 4126-1 and AD 2000-Merkblatt A2 (CE).



## Type 526

### Orifice G

Pressure temperature ratings

US units

Valve size	1 1/2 G 3	1 1/2 G 3	1 1/2 G 3	1 1/2 G 3	1 1/2 G 3	2 G 3	2 G 3
Flange rating class <small>Inlet x Outlet</small>	150 x 150	300L x 150	300 x 150	600 x 150	900 x 300	1500 x 300	2500 x 300
Actual Orifice diameter d <sub>0</sub> [inch]	0.886	0.886	0.886	0.886	0.886	0.886	0.886
Actual Orifice area A <sub>0</sub> [inch <sup>2</sup> ]	0.616	0.616	0.616	0.616	0.616	0.616	0.616
Minimum set pressure [psig] S/G/L	3.0 <sup>1)</sup>	3.0 <sup>1)</sup>	3.0 <sup>1)</sup>	3.0 <sup>1)</sup>	3.0 <sup>1)</sup>	73.0	73.0
Minimum set pressure [psig] S/G	46.6	46.6	46.6	133.4	133.4	133.4	133.4
Balanced bellows Inconel [psig] L	46.4	46.4	46.4	268.0	268.0	268.0	268.0
<b>Body material: WCB 1.0619</b>		<b>Pressure range p [psig] S/G/L</b>					
<b>Article numbers</b>	<b>5262.045<sup>o)</sup></b>	<b>5262.046<sup>o)</sup></b>	<b>5262.047<sup>o)</sup></b>	<b>5262.048<sup>o)</sup></b>	<b>5262.049<sup>o)</sup></b>	<b>5262.050<sup>o)</sup></b>	<b>5262.051<sup>o)</sup></b>
<b>Maximum set pressure</b>	-20 to 100 °F	285	285	740	1480	2220	3705
	450 °F	185	285	615	1235	1845	3080
	800 °F	80	285	410	825	1235	2060
<b>Outlet pressure limit</b> Conventional design	285	285	285	285	740	740	740
<b>Outlet pressure limit</b> Balanced bellows design	230	230	230	230	470	470	470
<b>Body material: CF8M 1.4408</b>		<b>Pressure range p [psig] S/G/L</b>					
<b>Article numbers</b>	<b>5264.110<sup>o)</sup></b>	<b>5264.111<sup>o)</sup></b>	<b>5264.112<sup>o)</sup></b>	<b>5264.113<sup>o)</sup></b>	<b>5264.114<sup>o)</sup></b>	<b>5264.115<sup>o)</sup></b>	<b>5264.116<sup>o)</sup></b>
<b>Maximum set pressure</b>	-450 to -76 °F	275	275	720	1440	2160	2450
	-75 to -21 °F	275	275	720	1440	2160	3600
	-20 to 100 °F	275	275	720	1440	2160	3600
	450 °F	180	275	495	975	1485	2480
	800 °F	80	275	420	845	1265	2110
	1000 °F	20	275	350	700	1050	1750
<b>Outlet pressure limit</b> Conventional design	275	275	275	275	720	720	720
<b>Outlet pressure limit</b> Balanced bellows design	230	230	230	230	470	470	470
<b>Body material: WC6 1.7357</b>		<b>Pressure range p [psig] S/G/L</b>					
<b>Article numbers</b>	–	–	<b>5267.052<sup>o)</sup></b>	<b>5267.053<sup>o)</sup></b>	<b>5267.054<sup>o)</sup></b>	<b>5267.055<sup>o)</sup></b>	<b>5267.056<sup>o)</sup></b>
<b>Maximum set pressure</b>	800 °F	–	510	1015	1525	2540	3705
	1000 °F	–	215	430	650	1080	1800
<b>Outlet pressure limit</b> Conventional design	–	–	285	285	740	740	740
<b>Outlet pressure limit</b> Balanced bellows design	–	–	230	230	470	470	470
<b>Body material: LCB</b>		<b>Pressure range p [psig] S/G/L</b>					
<b>Article numbers</b>	<b>5263.516<sup>o)</sup></b>	<b>5263.517<sup>o)</sup></b>	<b>5263.518<sup>o)</sup></b>	<b>5263.519<sup>o)</sup></b>	<b>5263.520<sup>o)</sup></b>	<b>5263.521<sup>o)</sup></b>	<b>5263.522<sup>o)</sup></b>
<b>Maximum set pressure</b>	-50 to 100 °F	265	265	695	1395	2090	3480
	400 °F	200	265	615	1230	1845	3075
	650 °F	125	265	535	1065	1600	2665
<b>Outlet pressure limit</b> Conventional design	265	265	265	265	695	695	695
<b>Outlet pressure limit</b> Balanced bellows design	230	230	230	230	470	470	470

<sup>o)</sup> Please add code for the required cap or lifting device. See page 11.

Remark: SA 352 Gr. LCB is not listed in the API 526. Pressure-Temperature Rating acc. to ASME B16.34 Table 2-1.3  
The stated Pressure-Temperature Rating are taken from ASME B16.34 Table 2-1.3 if the maximum pressure is not limited by API 526.

Due to the extended material test certificate the LESER LCB can be applied as LCC, WCB, WCC and 1.0619 with the respective pressure-temperature range as well.

<sup>1)</sup> The pressure range 3.0 – 36.25 psig is outside of the type test approval acc. to ISO 4126-1 and AD 2000-Merkblatt A2 (CE).

## Type 526

### Orifice H

#### Pressure temperature ratings

#### Metric units

Valve size	1 1/2 H 3	1 1/2 H 3	2 H 3	2 H 3	2 H 3	2 H 3
Flange rating class <small>Inlet x Outlet</small>	150 x 150	300L x 150	300 x 150	600 x 150	900 x 150	1500 x 300
Actual Orifice diameter $d_o$ [mm]	28.3	28.3	28.3	28.3	28.3	28.3
Actual Orifice area $A_o$ [mm <sup>2</sup> ]	625	625	625	625	625	625
Minimum set pressure [bar] S/G/L	0.2	0.2	0.3	0.3	0.3	0.3
Minimum set pressure [bar] S/G	3.2	3.2	6.5	6.5	6.5	6.5
Balanced bellows Inconel [bar] L	3.2	3.2	12.0	12.0	12.0	12.0
<b>Body material: WCB 1.0619</b>			<b>Pressure range p [bar] S/G/L</b>			
<b>Article numbers</b>	<b>5262.142<sup>o</sup></b>	<b>5262.143<sup>o</sup></b>	<b>5262.144<sup>o</sup></b>	<b>5262.145<sup>o</sup></b>	<b>5262.146<sup>o</sup></b>	<b>5262.147<sup>o</sup></b>
<b>Maximum set pressure</b>	-29 to 38 °C	19.7	19.7	51.0	102.1	153.1
	232 °C	12.8	19.7	42.4	85.2	127.2
	427 °C	5.5	19.7	28.3	56.9	85.2
<b>Outlet pressure limit</b> Conventional design	19.7	19.7	19.7	19.7	19.7	51.0
<b>Outlet pressure limit</b> Balanced bellows design	15.9	15.9	15.9	15.9	15.9	28.6
<b>Body material: CF8M 1.4408</b>			<b>Pressure range p [bar] S/G/L</b>			
<b>Article numbers</b>	<b>5264.152<sup>o</sup></b>	<b>5264.153<sup>o</sup></b>	<b>5264.154<sup>o</sup></b>	<b>5264.155<sup>o</sup></b>	<b>5264.156<sup>o</sup></b>	<b>5264.157<sup>o</sup></b>
<b>Maximum set pressure</b>	-268 to -60 °C	19.0	19.0	49.7	99.3	102.4
	-59 to -29 °C	19.0	19.0	49.7	99.3	149.0
	-28 to 38 °C	19.0	19.0	49.7	99.3	149.0
	232 °C	12.4	19.0	34.1	67.2	102.4
	427 °C	5.5	19.0	29.0	58.3	87.2
538 °C	1.4	19.0	24.1	48.3	72.4	120.7
<b>Outlet pressure limit</b> Conventional design	19.0	19.0	19.0	19.0	19.0	41.4
<b>Outlet pressure limit</b> Balanced bellows design	15.9	15.9	15.9	15.9	15.9	28.6
<b>Body material: WC6 1.7357</b>			<b>Pressure range p [bar] S/G/L</b>			
<b>Article numbers</b>	-	-	<b>5267.148<sup>o</sup></b>	<b>5267.149<sup>o</sup></b>	<b>5267.150<sup>o</sup></b>	<b>5267.151<sup>o</sup></b>
<b>Maximum set pressure</b>	427 °C	-	35.2	70.0	105.2	175.2
	538 °C	-	14.8	29.7	44.8	74.5
<b>Outlet pressure limit</b> Conventional design	-	-	19.7	19.7	19.7	51.0
<b>Outlet pressure limit</b> Balanced bellows design	-	-	15.9	15.9	15.9	28.6
<b>Body material: LCB</b>			<b>Pressure range p [bar] S/G/L</b>			
<b>Article numbers</b>	<b>5263.523<sup>o</sup></b>	<b>5263.524<sup>o</sup></b>	<b>5263.525<sup>o</sup></b>	<b>5263.526<sup>o</sup></b>	<b>5263.527<sup>o</sup></b>	<b>5263.528<sup>o</sup></b>
<b>Maximum set pressure</b>	-46 to 38 °C	18.4	18.4	48.0	96.0	144.1
	200 °C	13.8	18.4	42.5	85.1	127.6
	343 °C	8.4	18.4	36.4	72.8	109.2
<b>Outlet pressure limit</b> Conventional design	18.4	18.4	18.4	18.4	18.4	48.0
<b>Outlet pressure limit</b> Balanced bellows design	15.9	15.9	15.9	15.9	15.9	28.6

<sup>o</sup> Please add code for the required cap or lifting device. See page 11.

Remark: SA 352 Gr. LCB is not listed in the API 526. Pressure-Temperature Rating acc. to ASME B16.34 Table 2-1.3  
The stated Pressure-Temperature Rating are taken from ASME B16.34 Table 2-1.3 if the maximum pressure is not limited by API 526.

Due to the extended material test certificate the LESER LCB can be applied as LCC, WCB, WCC and 1.0619 with the respective pressure-temperature range as well.

## Type 526

### Orifice H

#### Pressure temperature ratings

#### US units

Valve size	1 1/2 H 3	1 1/2 H 3	2 H 3	2 H 3	2 H 3	2 H 3	
Flange rating class <small>Inlet x Outlet</small>	150 x 150	300L x 150	300 x 150	600 x 150	900 x 150	1500 x 300	
Actual Orifice diameter $d_0$ [inch]	1.11	1.11	1.11	1.11	1.11	1.11	
Actual Orifice area $A_0$ [inch <sup>2</sup> ]	0.975	0.975	0.975	0.975	0.975	0.975	
Minimum set pressure [psig] S/G/L	3.0	3.0	4.0	4.0	4.0	4.0	
Minimum set pressure [psig] S/G	46.4	46.4	94.3	94.3	94.3	94.3	
Balanced bellows Inconel [psig] L	46.4	46.4	174.0	174.0	174.0	174.0	
<b>Body material: WCB 1.0619</b>		<b>Pressure range p [psig] S/G/L</b>					
<b>Article numbers</b>	<b>5262.142<sup>o</sup></b>	<b>5262.143<sup>o</sup></b>	<b>5262.144<sup>o</sup></b>	<b>5262.145<sup>o</sup></b>	<b>5262.146<sup>o</sup></b>	<b>5262.147<sup>o</sup></b>	
<b>Maximum set pressure</b>	-20 to 100 °F	285	285	740	1480	2220	2750
	450 °F	185	285	615	1235	1845	2750
	800 °F	80	285	410	825	1235	2060
<b>Outlet pressure limit</b> Conventional design	285	285	285	285	285	740	
<b>Outlet pressure limit</b> Balanced bellows design	230	230	230	230	230	415	
<b>Body material: CF8M 1.4408</b>		<b>Pressure range p [psig] S/G/L</b>					
<b>Article numbers</b>	<b>5264.152<sup>o</sup></b>	<b>5264.153<sup>o</sup></b>	<b>5264.154<sup>o</sup></b>	<b>5264.155<sup>o</sup></b>	<b>5264.156<sup>o</sup></b>	<b>5264.157<sup>o</sup></b>	
<b>Maximum set pressure</b>	-450 to -76 °F	275	275	720	1440	1485	1600
	-75 to -21 °F	275	275	720	1440	2160	2750
	-20 to 100 °F	275	275	720	1440	2160	2750
	450 °F	180	275	495	975	1485	2480
	800 °F	80	275	420	845	1265	2110
	1000 °F	20	275	350	700	1050	1750
<b>Outlet pressure limit</b> Conventional design	275	275	275	275	275	600	
<b>Outlet pressure limit</b> Balanced bellows design	230	230	230	230	230	415	
<b>Body material: WC6 1.7357</b>		<b>Pressure range p [psig] S/G/L</b>					
<b>Article numbers</b>	-	-	<b>5267.148<sup>o</sup></b>	<b>5267.149<sup>o</sup></b>	<b>5267.150<sup>o</sup></b>	<b>5267.151<sup>o</sup></b>	
<b>Maximum set pressure</b>	800 °F	-	510	1015	1525	2540	
	1000 °F	-	215	430	650	1080	
<b>Outlet pressure limit</b> Conventional design	-	-	285	285	285	740	
<b>Outlet pressure limit</b> Balanced bellows design	-	-	230	230	230	415	
<b>Body material: LCB</b>		<b>Pressure range p [psig] S/G/L</b>					
<b>Article numbers</b>	<b>5263.523<sup>o</sup></b>	<b>5263.524<sup>o</sup></b>	<b>5263.525<sup>o</sup></b>	<b>5263.526<sup>o</sup></b>	<b>5263.527<sup>o</sup></b>	<b>5263.528<sup>o</sup></b>	
<b>Maximum set pressure</b>	-50 to 100 °F	265	265	695	1395	2090	2750
	400 °F	200	265	615	1230	1845	2750
	650 °F	125	265	535	1065	1600	2665
<b>Outlet pressure limit</b> Conventional design	265	265	265	265	265	695	
<b>Outlet pressure limit</b> Balanced bellows design	230	230	230	230	230	415	

<sup>o</sup>) Please add code for the required cap or lifting device. See page 11.

Remark: SA 352 Gr. LCB is not listed in the API 526. Pressure-Temperature Rating acc. to ASME B16.34 Table 2-1.3  
The stated Pressure-Temperature Rating are taken from ASME B16.34 Table 2-1.3 if the maximum pressure is not limited by API 526.

Due to the extended material test certificate the LESER LCB can be applied as LCC, WCB, WCC and 1.0619 with the respective pressure-temperature range as well.

## Type 526

### Orifice J

#### Pressure temperature ratings

#### Metric units

Valve size	2 J 3	2 J 3	3 J 4	3 J 4	3 J 4	3 J 4
Flange rating class <small>Inlet x Outlet</small>	150 x 150	300L x 150	300 x 150	600 x 150	900 x 150	1500 x 300
Actual Orifice diameter $d_0$ [mm]	36.0	36.0	36.0	36.0	36.0	36.0
Actual Orifice area $A_0$ [mm <sup>2</sup> ]	1018	1018	1018	1018	1018	1018
Minimum set pressure [bar] S/G/L	0.2	0.2	0.8	0.8	0.8	0.8
Minimum set pressure [bar] S/G	3.5	3.5	3.5	3.5	3.5	3.5
Balanced bellows Inconel [bar] L	5.0	5.0	5.0	5.0	5.0	5.0
<b>Body material: WCB 1.0619</b>			<b>Pressure range p [bar] S/G/L</b>			
<b>Article numbers</b>	<b>5262.162<sup>o</sup></b>	<b>5262.163<sup>o</sup></b>	<b>5262.164<sup>o</sup></b>	<b>5262.165<sup>o</sup></b>	<b>5262.166<sup>o</sup></b>	<b>5262.167<sup>o</sup></b>
<b>Maximum set pressure</b>	-29 to 38 °C	19.7	19.7	51.0	102.1	153.1
	232 °C	12.8	19.7	42.4	85.2	127.2
	427 °C	5.5	19.7	28.3	56.9	85.2
<b>Outlet pressure limit</b> Conventional design	19.7	19.7	19.7	19.7	19.7	41.4
<b>Outlet pressure limit</b> Balanced bellows design	15.9	15.9	15.9	15.9	15.9	15.9
<b>Body material: CF8M 1.4408</b>			<b>Pressure range p [bar] S/G/L</b>			
<b>Article numbers</b>	<b>5264.196<sup>o</sup></b>	<b>5264.197<sup>o</sup></b>	<b>5264.198<sup>o</sup></b>	<b>5264.199<sup>o</sup></b>	<b>5264.200<sup>o</sup></b>	<b>5264.201<sup>o</sup></b>
<b>Maximum set pressure</b>	-268 to -60 °C	19.0	19.0	34.5	43.1	55.2
	-59 to -29 °C	19.0	19.0	49.7	99.3	149.0
	-28 to 38 °C	19.0	19.0	49.7	99.3	149.0
	232 °C	12.4	19.0	34.1	67.2	102.4
	427 °C	5.5	19.0	29.0	58.3	87.2
538 °C	1.4	19.0	24.1	48.3	72.4	120.7
<b>Outlet pressure limit</b> Conventional design	19.0	19.0	19.0	19.0	19.0	41.4
<b>Outlet pressure limit</b> Balanced bellows design	15.9	15.9	15.9	15.9	15.9	15.9
<b>Body material: WC6 1.7357</b>			<b>Pressure range p [bar] S/G/L</b>			
<b>Article numbers</b>	-	-	<b>5267.168<sup>o</sup></b>	<b>5267.169<sup>o</sup></b>	<b>5267.170<sup>o</sup></b>	<b>5267.171<sup>o</sup></b>
<b>Maximum set pressure</b>	427 °C	-	35.2	70.0	105.2	175.2
	538 °C	-	14.8	29.7	44.8	74.5
<b>Outlet pressure limit</b> Conventional design	-	-	19.7	19.7	19.7	41.4
<b>Outlet pressure limit</b> Balanced bellows design	-	-	15.9	15.9	15.9	15.9
<b>Body material: LCB</b>			<b>Pressure range p [bar] S/G/L</b>			
<b>Article numbers</b>	<b>5263.529<sup>o</sup></b>	<b>5263.530<sup>o</sup></b>	<b>5263.531<sup>o</sup></b>	<b>5263.532<sup>o</sup></b>	<b>5263.533<sup>o</sup></b>	<b>5263.534<sup>o</sup></b>
<b>Maximum set pressure</b>	-46 to 38 °C	18.4	18.4	48.0	96.0	144.1
	200 °C	13.8	18.4	42.5	85.1	127.6
	343 °C	8.4	18.4	36.4	72.8	109.2
<b>Outlet pressure limit</b> Conventional design	18.4	18.4	18.4	18.4	18.4	41.4
<b>Outlet pressure limit</b> Balanced bellows design	15.9	15.9	15.9	15.9	15.9	15.9

<sup>o</sup> Please add code for the required cap or lifting device. See page 11.

Remark: SA 352 Gr. LCB is not listed in the API 526. Pressure-Temperature Rating acc. to ASME B16.34 Table 2-1.3  
The stated Pressure-Temperature Rating are taken from ASME B16.34 Table 2-1.3 if the maximum pressure is not limited by API 526.

Due to the extended material test certificate the LESER LCB can be applied as LCC, WCB, WCC and 1.0619 with the respective pressure-temperature range as well.

## Type 526

### Orifice J

#### Pressure temperature ratings

#### US units

Valve size	2 J 3	2 J 3	3 J 4	3 J 4	3 J 4	3 J 4	
Flange rating class <small>Inlet x Outlet</small>	150 x 150	300L x 150	300 x 150	600 x 150	900 x 150	1500 x 300	
Actual Orifice diameter $d_0$ [inch]	1.42	1.42	1.42	1.42	1.42	1.42	
Actual Orifice areat $A_0$ [inch <sup>2</sup> ]	1.58	1.58	1.58	1.58	1.58	1.58	
Minimum set pressure [psig] S/G/L	3.0	3.0	12.0	12.0	12.0	12.0	
Minimum set pressure [psig] S/G	50.8	50.8	50.8	50.8	50.8	50.8	
Balanced bellows Inconel [psig] L	72.5	72.5	72.5	72.5	72.5	72.5	
<b>Body material: WCB 1.0619</b>		<b>Pressure range p [psig] S/G/L</b>					
<b>Article numbers</b>	<b>5262.162<sup>a</sup></b>	<b>5262.163<sup>a</sup></b>	<b>5262.164<sup>a</sup></b>	<b>5262.165<sup>a</sup></b>	<b>5262.166<sup>a</sup></b>	<b>5262.167<sup>a</sup></b>	
<b>Maximum set pressure</b>	-20 to 100 °F	285	285	740	1480	2220	2700
	450 °F	185	285	615	1235	1845	2700
	800 °F	80	285	410	825	1235	2060
<b>Outlet pressure limit</b> Conventional design	285	285	285	285	285	600	
<b>Outlet pressure limit</b> Balanced bellows design	230	230	230	230	230	230	
<b>Body material: CF8M 1.4408</b>		<b>Pressure range p [psig] S/G/L</b>					
<b>Article numbers</b>	<b>5264.196<sup>a</sup></b>	<b>5264.197<sup>a</sup></b>	<b>5264.198<sup>a</sup></b>	<b>5264.199<sup>a</sup></b>	<b>5264.200<sup>a</sup></b>	<b>5264.201<sup>a</sup></b>	
<b>Maximum set pressure</b>	-450 to -76 °F	275	275	500	625	800	800
	-75 to -21 °F	275	275	720	1440	2160	2700
	-20 to 100 °F	275	275	720	1440	2160	2700
	450 °F	180	275	495	975	1485	2480
	800 °F	80	275	420	845	1265	2110
	1000 °F	20	275	350	700	1050	1750
<b>Outlet pressure limit</b> Conventional design	275	275	275	275	275	600	
<b>Outlet pressure limit</b> Balanced bellows design	230	230	230	230	230	230	
<b>Body material: WC6 1.7357</b>		<b>Pressure range p [psig] S/G/L</b>					
<b>Article numbers</b>	-	-	<b>5267.168<sup>a</sup></b>	<b>5267.169<sup>a</sup></b>	<b>5267.170<sup>a</sup></b>	<b>5267.171<sup>a</sup></b>	
<b>Maximum set pressure</b>	800 °F	-	510	1015	1525	2540	
	1000 °F	-	215	430	650	1080	
<b>Outlet pressure limit</b> Conventional design	-	-	285	285	285	600	
<b>Outlet pressure limit</b> Balanced bellows design	-	-	230	230	230	230	
<b>Body material: LCB</b>		<b>Pressure range p [psig] S/G/L</b>					
<b>Article numbers</b>	<b>5263.529<sup>a</sup></b>	<b>5263.530<sup>a</sup></b>	<b>5263.531<sup>a</sup></b>	<b>5263.532<sup>a</sup></b>	<b>5263.533<sup>a</sup></b>	<b>5263.534<sup>a</sup></b>	
<b>Maximum set pressure</b>	-50 to 100 °F	265	265	695	1395	2090	2700
	400 °F	200	265	615	1230	1845	2700
	650 °F	125	265	535	1065	1600	2665
<b>Outlet pressure limit</b> Conventional design	265	265	265	265	265	600	
<b>Outlet pressure limit</b> Balanced bellows design	230	230	230	230	230	230	

<sup>a)</sup> Please add code for the required cap or lifting device. See page 11.

Remark: SA 352 Gr. LCB is not listed in the API 526. Pressure-Temperature Rating acc. to ASME B16.34 Table 2-1.3  
The stated Pressure-Temperature Rating are taken from ASME B16.34 Table 2-1.3 if the maximum pressure is not limited by API 526.

Due to the extended material test certificate the LESER LCB can be applied as LCC, WCB, WCC and 1.0619 with the respective pressure-temperature range as well.

## Type 526

### Orifice K

#### Pressure temperature ratings

#### Metric units

Valve size	3 K 4	3 K 4	3 K 4	3 K 4	3 K 6	3 K 6	
Flange rating class <small>Inlet x Outlet</small>	150 x 150	300L x 150	300 x 150	600 x 150	900 x 150	1500 x 300	
Actual Orifice diameter $d_0$ [mm]	43.0	43.0	43.0	43.0	43.0	43.0	
Actual Orifice area $A_0$ [mm <sup>2</sup> ]	1452	1452	1452	1452	1452	1452	
Minimum set pressure [bar] S/G/L only WC6	0.3	0.3	0.3	0.3	2.3	2.3	
Minimum set pressure [bar] S/G	2.2	2.2	2.2	5.6	5.6	5.6	
Balanced bellows Inconel [bar] L	2.5	2.5	2.5	6.5	6.5	6.5	
<b>Body material: WCB 1.0619</b>		<b>Pressure range p [bar] S/G/L</b>					
<b>Article numbers</b>	<b>5262.202<sup>o</sup></b>	Use 3 K 4 300 x 150	<b>5262.203<sup>o</sup></b>	<b>5262.204<sup>o</sup></b>	<b>5262.205<sup>o</sup></b>	<b>5262.206<sup>o</sup></b>	
<b>Maximum set pressure</b>	-29 to 38 °C		19.7	51.0	102.1	153.1	153.1
	232 °C		12.8	42.4	85.2	127.2	153.1
	427 °C		5.5	28.3	56.9	85.2	142.1
<b>Outlet pressure limit</b> Conventional design			19.7	19.7	19.7	19.7	41.4
<b>Outlet pressure limit</b> Balanced bellows design			10.3	10.3	13.8	13.8	13.8
<b>Body material: CF8M 1.4408</b>		<b>Pressure range p [bar] S/G/L</b>					
<b>Article numbers</b>	<b>5264.211<sup>o</sup></b>	Use 3 K 4 300 x 150	<b>5264.212<sup>o</sup></b>	<b>5264.213<sup>o</sup></b>	<b>5264.214<sup>o</sup></b>	<b>5264.215<sup>o</sup></b>	
<b>Maximum set pressure</b>	-268 to -60 °C		19.0	36.2	41.4	41.4	51.7
	-59 to -29 °C		19.0	49.7	99.3	149.0	153.1
	-28 to 38 °C		19.0	49.7	99.3	149.0	153.1
	232 °C		12.4	34.1	67.2	102.4	153.1
	427 °C		5.5	29.0	58.3	87.2	145.5
	538 °C		1.4	24.1	48.3	72.4	120.7
<b>Outlet pressure limit</b> Conventional design		19.0	19.0	19.0	19.0	41.4	
<b>Outlet pressure limit</b> Balanced bellows design		10.3	10.3	13.8	13.8	13.8	
<b>Body material: WC6 1.7357</b>		<b>Pressure range p [bar] S/G/L</b>					
<b>Article numbers</b>	-	Use 3 K 4 300 x 150	<b>5267.207<sup>o</sup></b>	<b>5267.208<sup>o</sup></b>	<b>5267.209<sup>o</sup></b>	<b>5267.210<sup>o</sup></b>	
<b>Maximum set pressure</b>	427 °C		-	35.2	70.0	105.2	153.1
	538 °C		-	14.8	29.7	44.8	74.5
<b>Outlet pressure limit</b> Conventional design			-	19.7	19.7	19.7	41.4
<b>Outlet pressure limit</b> Balanced bellows design		-	10.3	13.8	13.8	13.8	
<b>Body material: LCB</b>		<b>Pressure range p [bar] S/G/L</b>					
<b>Article numbers</b>	<b>5263.535<sup>o</sup></b>	Use 3 K 4 300 x 150	<b>5263.536<sup>o</sup></b>	<b>5263.537<sup>o</sup></b>	<b>5263.538<sup>o</sup></b>	<b>5263.539<sup>o</sup></b>	
<b>Maximum set pressure</b>	-46 to 38 °C		18.4	48.0	96.0	144.1	153.1
	200 °C		13.8	42.5	85.1	127.6	153.1
	343 °C		8.4	36.4	72.8	109.2	153.1
<b>Outlet pressure limit</b> Conventional design			18.4	18.4	18.4	18.4	41.4
<b>Outlet pressure limit</b> Balanced bellows design		10.3	10.3	13.8	13.8	13.8	

<sup>o</sup>) Please add code for the required cap or lifting device. See page 11.

Remark: SA 352 Gr. LCB is not listed in the API 526. Pressure-Temperature Rating acc. to ASME B16.34 Table 2-1.3  
The stated Pressure-Temperature Rating are taken from ASME B16.34 Table 2-1.3 if the maximum pressure is not limited by API 526.

Due to the extended material test certificate the LESER LCB can be applied as LCC, WCB, WCC and 1.0619 with the respective pressure-temperature range as well.

## Type 526

### Orifice K

#### Pressure temperature ratings

#### US units

Valve size	3 K 4	3 K 4	3 K 4	3 K 4	3 K 6	3 K 6	
Flange rating class <small>Inlet x Outlet</small>	150 x 150	300L x 150	300 x 150	600 x 150	900 x 150	1500 x 300	
Actual Orifice diameter $d_0$ [inch]	1.69	1.69	1.69	1.69	1.69	1.69	
Actual Orifice area $A_0$ [inch <sup>2</sup> ]	2.25	2.25	2.25	2.25	2.25	2.25	
Minimum [psig] S/G/L set pressure only WC6	4.0	4.0	4.0	4.0	33.0	33.0	
Minimum set pressure [psig] S/G	31.9	31.9	31.9	81.2	81.2	81.2	
Balanced bellows Inconel [psig] L	36.3	36.3	36.3	94.3	94.3	94.3	
<b>Body material: WCB 1.0619</b>		<b>Pressure range p [psig] S/G/L</b>					
<b>Article numbers</b>	<b>5262.202<sup>a</sup></b>	Use 3 K 4 300 x 150	<b>5262.203<sup>a</sup></b>	<b>5262.204<sup>a</sup></b>	<b>5262.205<sup>a</sup></b>	<b>5262.206<sup>a</sup></b>	
<b>Maximum set pressure</b>	-20 to 100 °F		285	740	1480	2220	2220
	450 °F		185	615	1235	1845	2220
	800 °F		80	410	825	1235	2060
<b>Outlet pressure limit</b> Conventional design			285	285	285	285	600
<b>Outlet pressure limit</b> Balanced bellows design			150	150	200	200	200
<b>Body material: CF8M 1.4408</b>		<b>Pressure range p [psig] S/G/L</b>					
<b>Article numbers</b>	<b>5264.211<sup>a</sup></b>	Use 3 K 4 300 x 150	<b>5264.212<sup>a</sup></b>	<b>5264.213<sup>a</sup></b>	<b>5264.214<sup>a</sup></b>	<b>5264.215<sup>a</sup></b>	
<b>Maximum set pressure</b>	-450 to -76 °F		275	525	600	600	750
	-75 to -21 °F		275	720	1440	2160	2220
	-20 to 100 °F		275	720	1440	2160	2220
	450 °F		180	495	975	1485	2220
	800 °F		80	420	845	1265	2110
	1000 °F	20	350	700	1050	1750	
<b>Outlet pressure limit</b> Conventional design		275	275	275	275	600	
<b>Outlet pressure limit</b> Balanced bellows design		150	150	200	200	200	
<b>Body material: WC6 1.7357</b>		<b>Pressure range p [psig] S/G/L</b>					
<b>Article numbers</b>	<b>-</b>	Use 3 K 4 300 x 150	<b>5267.207<sup>a</sup></b>	<b>5267.208<sup>a</sup></b>	<b>5267.209<sup>a</sup></b>	<b>5267.210<sup>a</sup></b>	
<b>Maximum set pressure</b>	800 °F		-	510	1015	1525	2220
	1000 °F		-	215	430	650	1080
<b>Outlet pressure limit</b> Conventional design			-	285	285	285	600
<b>Outlet pressure limit</b> Balanced bellows design			-	150	200	200	200
<b>Body material: LCB</b>			<b>Pressure range p [psig] S/G/L</b>				
<b>Article numbers</b>	<b>5263.535<sup>a</sup></b>	Use 3 K 4 300 x 150	<b>5263.536<sup>a</sup></b>	<b>5263.537<sup>a</sup></b>	<b>5263.538<sup>a</sup></b>	<b>5263.539<sup>a</sup></b>	
<b>Maximum set pressure</b>	-50 to 100 °F		265	695	1395	2090	2220
	400 °F		200	615	1230	1845	2220
	650 °F		125	535	1065	1600	2220
<b>Outlet pressure limit</b> Conventional design			265	265	265	265	600
<b>Outlet pressure limit</b> Balanced bellows design			150	150	200	200	200

<sup>a)</sup> Please add code for the required cap or lifting device. See page 11.

Remark: SA 352 Gr. LCB is not listed in the API 526. Pressure-Temperature Rating acc. to ASME B16.34 Table 2-1.3  
The stated Pressure-Temperature Rating are taken from ASME B16.34 Table 2-1.3 if the maximum pressure is not limited by API 526.

Due to the extended material test certificate the LESER LCB can be applied as LCC, WCB, WCC and 1.0619 with the respective pressure-temperature range as well.

## Type 526

### Orifice L

#### Pressure temperature ratings

#### Metric units

Valve size	3 L 4	3 L 4	4 L 6	4 L 6	4 L 6	4 L 6
Flange rating class <small>Inlet x Outlet</small>	150 x 150	300L x 150	300 x 150	600 x 150	900 x 150	1500 x 150
Actual Orifice diameter $d_0$ [mm]	53.5	53.5	53.5	53.5	53.5	53.5
Actual Orifice area $A_0$ [mm <sup>2</sup> ]	2248	2248	2248	2248	2248	2248
Minimum set pressure [bar] S/G/L	0.3	0.3	0.2	0.2	0.2	0.2
Minimum set pressure [bar] S/G	3.5	3.5	3.5	3.5	3.5	3.5
Balanced bellows Inconel [bar] L	3.5	3.5	6.0	6.0	6.0	6.0
<b>Body material: WCB 1.0619</b>			<b>Pressure range p [bar] S/G/L</b>			
<b>Article numbers</b>	<b>5262.232<sup>o</sup></b>	<b>5262.233<sup>o</sup></b>	<b>5262.234<sup>o</sup></b>	<b>5262.235<sup>o</sup></b>	<b>5262.236<sup>o</sup></b>	<b>5262.237<sup>o</sup></b>
<b>Maximum set pressure</b>	-29 to 38 °C	19.7	19.7	51.0	69.0	103.4
	232 °C	12.8	19.7	42.4	69.0	103.4
	427 °C	5.5	19.7	28.3	56.9	85.2
<b>Outlet pressure limit</b> Conventional design	19.7	19.7	19.7	19.7	19.7	19.7
<b>Outlet pressure limit</b> Balanced bellows design	6.9	6.9	11.7	11.7	11.7	11.7
<b>Body material: CF8M 1.4408</b>			<b>Pressure range p [bar] S/G/L</b>			
<b>Article numbers</b>	<b>5264.242<sup>o</sup></b>	<b>5264.243<sup>o</sup></b>	<b>5264.244<sup>o</sup></b>	<b>5264.245<sup>o</sup></b>	<b>5264.246<sup>o</sup></b>	<b>-</b>
<b>Maximum set pressure</b>	-268 to -60 °C	19.0	19.0	36.9	36.9	48.3
	-59 to -29 °C	19.0	19.0	49.7	69.0	103.4
	-28 to 38 °C	19.0	19.0	49.7	69.0	103.4
	232 °C	12.4	19.0	34.1	67.2	102.4
	427 °C	5.5	19.0	29.0	58.3	87.2
538 °C	1.4	19.0	24.1	48.3	72.4	
<b>Outlet pressure limit</b> Conventional design	19.0	19.0	19.0	19.0	19.0	-
<b>Outlet pressure limit</b> Balanced bellows design	6.9	6.9	11.7	11.7	11.7	-
<b>Body material: WC6 1.7357</b>			<b>Pressure range p [bar] S/G/L</b>			
<b>Article numbers</b>	<b>-</b>	<b>-</b>	<b>5267.238<sup>o</sup></b>	<b>5267.239<sup>o</sup></b>	<b>5267.240<sup>o</sup></b>	<b>5267.241<sup>o</sup></b>
<b>Maximum set pressure</b>	427 °C	-	35.2	69.0	103.4	103.4
	538 °C	-	14.8	29.7	44.8	74.5
<b>Outlet pressure limit</b> Conventional design	-	-	19.7	19.7	19.7	19.7
<b>Outlet pressure limit</b> Balanced bellows design	-	-	11.7	11.7	11.7	11.7
<b>Body material: LCB</b>			<b>Pressure range p [bar] S/G/L</b>			
<b>Article numbers</b>	<b>5263.540<sup>o</sup></b>	<b>5263.541<sup>o</sup></b>	<b>5263.542<sup>o</sup></b>	<b>5263.543<sup>o</sup></b>	<b>5263.544<sup>o</sup></b>	<b>5263.545<sup>o</sup></b>
<b>Maximum set pressure</b>	-46 to 38 °C	18.4	18.4	48.0	69.0	103.4
	200 °C	13.8	18.4	42.5	69.0	103.4
	343 °C	8.4	18.4	36.4	69.0	103.4
<b>Outlet pressure limit</b> Conventional design	18.4	18.4	18.4	18.4	18.4	18.4
<b>Outlet pressure limit</b> Balanced bellows design	6.9	6.9	11.7	11.7	11.7	11.7

<sup>o</sup> Please add code for the required cap or lifting device. See page 11.

Remark: SA 352 Gr. LCB is not listed in the API 526. Pressure-Temperature Rating acc. to ASME B16.34 Table 2-1.3  
The stated Pressure-Temperature Rating are taken from ASME B16.34 Table 2-1.3 if the maximum pressure is not limited by API 526.

Due to the extended material test certificate the LESER LCB can be applied as LCC, WCB, WCC and 1.0619 with the respective pressure-temperature range as well.



## Type 526

### Orifice L

#### Pressure temperature ratings

#### US units

Valve size	3 L 4	3 L 4	4 L 6	4 L 6	4 L 6	4 L 6
Flange rating class <small>Inlet x Outlet</small>	150 x 150	300L x 150	300 x 150	600 x 150	900 x 150	1500 x 150
Actual Orifice diameter $d_0$ [inch]	2.11	2.11	2.11	2.11	2.11	2.11
Actual Orifice area $A_0$ [inch <sup>2</sup> ]	3.48	3.48	3.48	3.48	3.48	3.48
Minimum set pressure [psig] S/G/L	4.0	4.0	3.0	3.0	3.0	3.0
Minimum set pressure [psig] S/G	50.8	50.8	50.8	50.8	50.8	50.8
Balanced bellows Inconel [psig] L	50.8	50.8	87.0	87.0	87.0	87.0
<b>Body material: WCB 1.0619</b>		<b>Pressure range p [psig] S/G/L</b>				
<b>Article numbers</b>	<b>5262.232<sup>o</sup></b>	<b>5262.233<sup>o</sup></b>	<b>5262.234<sup>o</sup></b>	<b>5262.235<sup>o</sup></b>	<b>5262.236<sup>o</sup></b>	<b>5262.237<sup>o</sup></b>
<b>Maximum set pressure</b>	-20 to 100 °F	285	285	740	1000	1500
	450 °F	185	285	615	1000	1500
	800 °F	80	285	410	825	1235
<b>Outlet pressure limit</b> Conventional design	285	285	285	285	285	285
<b>Outlet pressure limit</b> Balanced bellows design	100	100	170	170	170	170
<b>Body material: CF8M 1.4408</b>		<b>Pressure range p [psig] S/G/L</b>				
<b>Article numbers</b>	<b>5264.242<sup>o</sup></b>	<b>5264.243<sup>o</sup></b>	<b>5264.244<sup>o</sup></b>	<b>5264.245<sup>o</sup></b>	<b>5264.246<sup>o</sup></b>	<b>-</b>
<b>Maximum set pressure</b>	-450 to -76 °F	275	275	535	535	700
	-75 to -21 °F	275	275	720	1000	1500
	-20 to 100 °F	275	275	720	1000	1500
	450 °F	180	275	495	975	1485
	800 °F	80	275	420	845	1265
	1000 °F	20	275	350	700	1050
<b>Outlet pressure limit</b> Conventional design	275	275	275	275	275	-
<b>Outlet pressure limit</b> Balanced bellows design	100	100	170	170	170	-
<b>Body material: WC6 1.7357</b>		<b>Pressure range p [psig] S/G/L</b>				
<b>Article numbers</b>	<b>-</b>	<b>-</b>	<b>5267.238<sup>o</sup></b>	<b>5267.239<sup>o</sup></b>	<b>5267.240<sup>o</sup></b>	<b>5267.241<sup>o</sup></b>
<b>Maximum set pressure</b>	800 °F	-	510	1000	1500	1500
	1000 °F	-	215	430	650	1080
<b>Outlet pressure limit</b> Conventional design	-	-	285	285	285	285
<b>Outlet pressure limit</b> Balanced bellows design	-	-	170	170	170	170
<b>Body material: LCB</b>		<b>Pressure range p [psig] S/G/L</b>				
<b>Article numbers</b>	<b>5263.540<sup>o</sup></b>	<b>5263.541<sup>o</sup></b>	<b>5263.542<sup>o</sup></b>	<b>5263.543<sup>o</sup></b>	<b>5263.544<sup>o</sup></b>	<b>5263.545<sup>o</sup></b>
<b>Maximum set pressure</b>	-50 to 100 °F	265	265	695	1000	1500
	400 °F	200	265	615	1000	1500
	650 °F	125	265	535	1000	1500
<b>Outlet pressure limit</b> Conventional design	265	265	265	265	265	265
<b>Outlet pressure limit</b> Balanced bellows design	100	100	170	170	170	170

<sup>o</sup>) Please add code for the required cap or lifting device. See page 11.

Remark: SA 352 Gr. LCB is not listed in the API 526. Pressure-Temperature Rating acc. to ASME B16.34 Table 2-1.3  
The stated Pressure-Temperature Rating are taken from ASME B16.34 Table 2-1.3 if the maximum pressure is not limited by API 526.

Due to the extended material test certificate the LESER LCB can be applied as LCC, WCB, WCC and 1.0619 with the respective pressure-temperature range as well.

## Type 526

### Orifice M

#### Pressure temperature ratings

#### Metric units

Valve size	4 M 6	4 M 6	4 M 6	4 M 6	4 M 6	
Flange rating class <small>Inlet x Outlet</small>	150 x 150	300L x 150	300 x 150	600 x 150	900 x 150	
Actual Orifice diameter $d_0$ [mm]	60.3	60.3	60.3	60.3	60.3	
Actual Orifice area $A_0$ [mm <sup>2</sup> ]	2846	2846	2846	2846	2846	
Minimum set pressure [bar] S/G/L	0.2	0.2	0.2	0.2	0.2	
Minimum set pressure [bar] S/G	2.6	2.6	2.6	6.3	10.5	
Balanced bellows Inconel [bar] L	2.2	2.2	2.2	10.5	10.5	
<b>Body material: WCB 1.0619</b>		<b>Pressure range p [bar] S/G/L</b>				
<b>Article numbers</b>	<b>5262.580<sup>o</sup></b>	Use 4 M 6 300 x 150	<b>5262.581<sup>o</sup></b>	<b>5262.582<sup>o</sup></b>	<b>5262.583<sup>o</sup></b>	
<b>Maximum set pressure</b>	-29 to 38 °C		19.7	51.0	75.9	75.9
	232 °C		12.8	42.4	75.9	75.9
	427 °C		5.5	28.3	56.9	75.9
<b>Outlet pressure limit</b> Conventional design	19.7		19.7	19.7	19.7	19.7
<b>Outlet pressure limit</b> Balanced bellows design	5.5		11.0	11.0	11.0	11.0
<b>Body material: CF8M 1.4408</b>		<b>Pressure range p [bar] S/G/L</b>				
<b>Article numbers</b>	<b>5264.587<sup>o</sup></b>	Use 4 M 6 300 x 150	<b>5264.588<sup>o</sup></b>	<b>5264.589<sup>o</sup></b>	-	
<b>Maximum set pressure</b>	-268 to -60 °C		19.0	36.2	41.4	-
	-59 to -29 °C		19.0	49.7	69.0	-
	-28 to 38 °C		19.0	49.7	69.0	-
	232 °C		12.4	34.1	67.2	-
	427 °C		5.5	29.0	58.3	-
538 °C	1.4		24.1	48.3	-	
<b>Outlet pressure limit</b> Conventional design	19.0	19.0	19.0	-	-	
<b>Outlet pressure limit</b> Balanced bellows design	5.5	11.0	11.0	-	-	
<b>Body material: WC6 1.7357</b>		<b>Pressure range p [bar] S/G/L</b>				
<b>Article numbers</b>	-	Use 4 M 6 300 x 150	<b>5267.584<sup>o</sup></b>	<b>5267.585<sup>o</sup></b>	<b>5267.586<sup>o</sup></b>	
<b>Maximum set pressure</b>	427 °C		-	35.2	69.0	75.8
	538 °C		-	14.8	29.7	44.8
<b>Outlet pressure limit</b> Conventional design	-		19.7	19.7	19.7	19.7
<b>Outlet pressure limit</b> Balanced bellows design	-		11.0	11.0	11.0	11.0
<b>Body material: LCB</b>		<b>Pressure range p [bar] S/G/L</b>				
<b>Article numbers</b>	<b>5263.546<sup>o</sup></b>	Use 4 M 6 300 x 150	<b>5263.547<sup>o</sup></b>	<b>5263.548<sup>o</sup></b>	<b>5263.549<sup>o</sup></b>	
<b>Maximum set pressure</b>	-46 to 38 °C		18.4	48.0	75.9	75.9
	200 °C		13.8	42.5	75.9	75.9
	343 °C		8.4	36.4	72.8	75.9
<b>Outlet pressure limit</b> Conventional design	18.4		18.4	18.4	18.4	18.4
<b>Outlet pressure limit</b> Balanced bellows design	5.5		11.0	11.0	11.0	11.0

<sup>o</sup> Please add code for the required cap or lifting device. See page 11.

Remark: SA 352 Gr. LCB is not listed in the API 526. Pressure-Temperature Rating acc. to ASME B16.34 Table 2-1.3  
The stated Pressure-Temperature Rating are taken from ASME B16.34 Table 2-1.3 if the maximum pressure is not limited by API 526.

Due to the extended material test certificate the LESER LCB can be applied as LCC, WCB, WCC and 1.0619 with the respective pressure-temperature range as well.

## Type 526

### Orifice M

#### Pressure temperature ratings

#### US units

Valve size	4 M 6	4 M 6	4 M 6	4 M 6	4 M 6	
Flange rating class <small>Inlet x Outlet</small>	150 x 150	300L x 150	300 x 150	600 x 150	900 x 150	
Actual Orifice diameter $d_0$ [inch]	2.37	2.37	2.37	2.37	2.37	
Actual Orifice area $A_0$ [inch <sup>2</sup> ]	4.43	4.43	4.43	4.43	4.43	
Minimum set pressure [psig] S/G/L	3.0	3.0	3.0	3.0	3.0	
Minimum set pressure [psig] S/G	37.7	37.7	37.7	91.4	152.3	
Balanced bellows Inconel [psig] L	31.9	31.9	31.9	152.3	152.3	
<b>Body material: WCB 1.0619</b>		<b>Pressure range p [psig] S/G/L</b>				
<b>Article numbers</b>	<b>5262.580<sup>o</sup></b>	Use 4 M 6 300 x 150	<b>5262.581<sup>o</sup></b>	<b>5262.582<sup>o</sup></b>	<b>5262.583<sup>o</sup></b>	
<b>Maximum set pressure</b>	-20 to 100 °F		285	740	1100	1100
	450 °F		185	615	1100	1100
	800 °F		80	410	825	1100
<b>Outlet pressure limit</b> Conventional design	285		285	285	285	285
<b>Outlet pressure limit</b> Balanced bellows design	80		160	160	160	160
<b>Body material: CF8M 1.4408</b>		<b>Pressure range p [psig] S/G/L</b>				
<b>Article numbers</b>	<b>5264.587<sup>o</sup></b>	Use 4 M 6 300 x 150	<b>5264.588<sup>o</sup></b>	<b>5264.589<sup>o</sup></b>	-	
<b>Maximum set pressure</b>	-450 to -76 °F		275	525	600	-
	-75 to -21 °F		275	720	1000	-
	-20 to 100 °F		275	720	1000	-
	450 °F		180	495	975	-
	800 °F		80	420	845	-
1000 °F	20		350	700	-	
<b>Outlet pressure limit</b> Conventional design	275		275	275	-	-
<b>Outlet pressure limit</b> Balanced bellows design	80	160	160	-	-	
<b>Body material: WC6 1.7357</b>		<b>Pressure range p [psig] S/G/L</b>				
<b>Article numbers</b>	-	Use 4 M 6 300 x 150	<b>5267.584<sup>o</sup></b>	<b>5267.585<sup>o</sup></b>	<b>5267.586<sup>o</sup></b>	
<b>Maximum set pressure</b>	800 °F		-	510	1000	1100
	1000 °F		-	215	430	650
<b>Outlet pressure limit</b> Conventional design	-		285	285	285	285
<b>Outlet pressure limit</b> Balanced bellows design	-		160	160	160	160
<b>Body material: LCB</b>		<b>Pressure range p [psig] S/G/L</b>				
<b>Article numbers</b>	<b>5263.546<sup>o</sup></b>	Use 4 M 6 300 x 150	<b>5263.547<sup>o</sup></b>	<b>5263.548<sup>o</sup></b>	<b>5263.549<sup>o</sup></b>	
<b>Maximum set pressure</b>	-50 to 100 °F		265	695	1100	1100
	400 °F		200	615	1100	1100
	650 °F		125	535	1065	1100
<b>Outlet pressure limit</b> Conventional design	265		265	265	265	265
<b>Outlet pressure limit</b> Balanced bellows design	80		160	160	160	160

<sup>o</sup>) Please add code for the required cap or lifting device. See page 11.

Remark: SA 352 Gr. LCB is not listed in the API 526. Pressure-Temperature Rating acc. to ASME B16.34 Table 2-1.3  
The stated Pressure-Temperature Rating are taken from ASME B16.34 Table 2-1.3 if the maximum pressure is not limited by API 526.

Due to the extended material test certificate the LESER LCB can be applied as LCC, WCB, WCC and 1.0619 with the respective pressure-temperature range as well.

## Type 526

### Orifice N

#### Pressure temperature ratings

#### Metric units

Valve size	4 N 6	4 N 6	4 N 6	4 N 6	4 N 6	
Flange rating class <small>Inlet x Outlet</small>	150 x 150	300L x 150	300 x 150	600 x 150	900 x 150	
Actual Orifice diameter $d_0$ [mm]	66.0	66.0	66.0	66.0	66.0	
Actual Orifice area $A_0$ [mm <sup>2</sup> ]	3421	3421	3421	3421	3421	
Minimum set pressure [bar] S/G/L	0.2	0.2	0.2	0.2	0.2	
Minimum set pressure [bar] S/G	1.8	1.8	1.8	5.2	5.2	
Balanced bellows Inconel [bar] L	1.8	1.8	1.8	8.9	8.9	
<b>Body material: WCB 1.0619</b>		<b>Pressure range p [bar] S/G/L</b>				
<b>Article numbers</b>	<b>5262.590<sup>o</sup></b>	Use 4 N 6 300 x 150	<b>5262.591<sup>o</sup></b>	<b>5262.592<sup>o</sup></b>	<b>5262.593<sup>o</sup></b>	
<b>Maximum set pressure</b>	-29 to 38 °C		19.7	51.0	69.0	69.0
	232 °C		12.8	42.4	69.0	69.0
	427 °C		5.5	28.3	56.9	69.0
<b>Outlet pressure limit</b> Conventional design	19.7		19.7	19.7	19.7	19.7
<b>Outlet pressure limit</b> Balanced bellows design	5.5		11.0	11.0	11.0	11.0
<b>Body material: CF8M 1.4408</b>		<b>Pressure range p [bar] S/G/L</b>				
<b>Article numbers</b>	<b>5264.597<sup>o</sup></b>	Use 4 N 6 300 x 150	<b>5264.598<sup>o</sup></b>	<b>5264.599<sup>o</sup></b>	-	
<b>Maximum set pressure</b>	-268 to -60 °C		19.0	31.0	34.5	-
	-59 to -29 °C		19.0	49.7	69.0	-
	-28 to 38 °C		19.0	49.7	69.0	-
	232 °C		12.4	34.1	67.2	-
	427 °C		5.5	29.0	58.3	-
538 °C	1.4		24.1	48.3	-	
<b>Outlet pressure limit</b> Conventional design	19.0	19.0	19.0	-	-	
<b>Outlet pressure limit</b> Balanced bellows design	5.5	11.0	11.0	-	-	
<b>Body material: WC6 1.7357</b>		<b>Pressure range p [bar] S/G/L</b>				
<b>Article numbers</b>	-	Use 4 N 6 300 x 150	<b>5267.594<sup>o</sup></b>	<b>5267.595<sup>o</sup></b>	<b>5267.596<sup>o</sup></b>	
<b>Maximum set pressure</b>	427 °C		-	35.2	69.0	69.0
	538 °C		-	14.8	29.7	44.8
<b>Outlet pressure limit</b> Conventional design	-		19.7	19.7	19.7	19.7
<b>Outlet pressure limit</b> Balanced bellows design	-	11.0	11.0	11.0	11.0	
<b>Body material: LCB</b>		<b>Pressure range p [bar] S/G/L</b>				
<b>Article numbers</b>	<b>5263.550<sup>o</sup></b>	Use 4 N 6 300 x 150	<b>5263.551<sup>o</sup></b>	<b>5263.552<sup>o</sup></b>	<b>5263.553<sup>o</sup></b>	
<b>Maximum set pressure</b>	-46 to 38 °C		18.4	48.0	69.0	69.0
	200 °C		13.8	42.5	69.0	69.0
	343 °C		8.4	36.4	69.0	69.0
<b>Outlet pressure limit</b> Conventional design	18.4		18.4	18.4	18.4	18.4
<b>Outlet pressure limit</b> Balanced bellows design	5.5	11.0	11.0	11.0	11.0	

<sup>o</sup>) Please add code for the required cap or lifting device. See page 11.

Remark: SA 352 Gr. LCB is not listed in the API 526. Pressure-Temperature Rating acc. to ASME B16.34 Table 2-1.3  
The stated Pressure-Temperature Rating are taken from ASME B16.34 Table 2-1.3 if the maximum pressure is not limited by API 526.

Due to the extended material test certificate the LESER LCB can be applied as LCC, WCB, WCC and 1.0619 with the respective pressure-temperature range as well.

## Type 526

### Orifice N

#### Pressure temperature ratings

#### US units

Valve size	4 N 6	4 N 6	4 N 6	4 N 6	4 N 6	
Flange rating class <small>Inlet x Outlet</small>	150 x 150	300L x 150	300 x 150	600 x 150	900 x 150	
Actual Orifice diameter $d_0$ [inch]	2.60	2.60	2.60	2.60	2.60	
Actual Orifice area $A_0$ [inch <sup>2</sup> ]	5.30	5.30	5.30	5.30	5.30	
Minimum set pressure [psig] S/G/L	3.0	3.0	3.0	3.0	3.0	
Minimum set pressure [psig] S/G	26.1	26.1	26.1	75.4	75.4	
Balanced bellows Inconel [psig] L	26.1	26.1	26.1	129.0	129.0	
<b>Body material: WCB 1.0619</b>		<b>Pressure range p [psig] S/G/L</b>				
<b>Article numbers</b>	<b>5262.590<sup>o</sup></b>	Use 4 N 6 300 x 150	<b>5262.591<sup>o</sup></b>	<b>5262.592<sup>o</sup></b>	<b>5262.593<sup>o</sup></b>	
<b>Maximum set pressure</b>	-20 to 100 °F		285	740	1000	1000
	450 °F		185	615	1000	1000
	800 °F		80	410	825	1000
<b>Outlet pressure limit</b> Conventional design	285		285	285	285	285
<b>Outlet pressure limit</b> Balanced bellows design	80	160	160	160	160	
<b>Body material: CF8M 1.4408</b>		<b>Pressure range p [psig] S/G/L</b>				
<b>Article numbers</b>	<b>5264.597<sup>o</sup></b>	Use 4 N 6 300 x 150	<b>5264.598<sup>o</sup></b>	<b>5264.599<sup>o</sup></b>	-	
<b>Maximum set pressure</b>	-450 to -76 °F		275	450	500	-
	-75 to -21 °F		275	720	1000	-
	-20 to 100 °F		275	720	1000	-
	450 °F		180	495	975	-
	800 °F		80	420	845	-
1000 °F	20		350	700	-	
<b>Outlet pressure limit</b> Conventional design	275	275	275	-	-	
<b>Outlet pressure limit</b> Balanced bellows design	80	160	160	-	-	
<b>Body material: WC6 1.7357</b>		<b>Pressure range p [psig] S/G/L</b>				
<b>Article numbers</b>	-	Use 4 N 6 300 x 150	<b>5267.594<sup>o</sup></b>	<b>5267.595<sup>o</sup></b>	<b>5267.596<sup>o</sup></b>	
<b>Maximum set pressure</b>	800 °F		-	510	1000	1000
	1000 °F		-	215	430	650
<b>Outlet pressure limit</b> Conventional design	-		285	285	285	285
<b>Outlet pressure limit</b> Balanced bellows design	-		160	160	160	160
<b>Body material: LCB</b>		<b>Pressure range p [psig] S/G/L</b>				
<b>Article numbers</b>	<b>5263.550<sup>o</sup></b>	Use 4 N 6 300 x 150	<b>5263.551<sup>o</sup></b>	<b>5263.552<sup>o</sup></b>	<b>5263.553<sup>o</sup></b>	
<b>Maximum set pressure</b>	-50 to 100 °F		265	695	1000	1000
	400 °F		200	615	1000	1000
	650 °F		125	535	1000	1000
<b>Outlet pressure limit</b> Conventional design	265		265	265	265	
<b>Outlet pressure limit</b> Balanced bellows design	80	160	160	160		

<sup>o</sup>) Please add code for the required cap or lifting device. See page 11.

Remark: SA 352 Gr. LCB is not listed in the API 526. Pressure-Temperature Rating acc. to ASME B16.34 Table 2-1.3  
The stated Pressure-Temperature Rating are taken from ASME B16.34 Table 2-1.3 if the maximum pressure is not limited by API 526.

Due to the extended material test certificate the LESER LCB can be applied as LCC, WCB, WCC and 1.0619 with the respective pressure-temperature range as well.

## Type 526

### Orifice P

#### Pressure temperature ratings

#### Metric units

Valve size	4 P 6	4 P 6	4 P 6	4 P 6	4 P 6
Flange rating class <small>Inlet x Outlet</small>	150 x 150	300L x 150	300 x 150	600 x 150	900 x 150
Actual Orifice diameter $d_0$ [mm]	80.0	80.0	80.0	80.0	80.0
Actual Orifice area $A_0$ [mm <sup>2</sup> ]	5027	5027	5027	5027	5027
Minimum set pressure [bar] S/G/L	0.12	0.12	0.25	0.25	0.25
Minimum set pressure [bar] S/G	2.3	2.3	2.3	2.3	2.3
Balanced bellows Inconel [bar] L	2.5	2.5	2.5	2.5	2.5
<b>Body material: WCB 1.0619</b>					
<b>Pressure range p [bar] S/G/L</b>					
<b>Article numbers</b>	<b>5262.645<sup>o</sup></b>	<b>5262.646<sup>o</sup></b>	<b>5262.647<sup>o</sup></b>	<b>5262.648<sup>o</sup></b>	<b>5262.649<sup>o</sup></b>
<b>Maximum set pressure</b>	-29 to 38 °C	19.7	19.7	36.2	69.0
	232 °C	12.8	19.7	36.2	69.0
	427 °C	5.5	19.7	28.3	56.9
<b>Outlet pressure limit</b> Conventional design	19.7	19.7	19.7	19.7	19.7
<b>Outlet pressure limit</b> Balanced bellows design	5.5	5.5	10.3	10.3	10.3
<b>Body material: CF8M 1.4408</b>					
<b>Pressure range p [bar] S/G/L</b>					
<b>Article numbers</b>	<b>5264.653<sup>o</sup></b>	<b>5264.654<sup>o</sup></b>	<b>5264.655<sup>o</sup></b>	<b>5264.656<sup>o</sup></b>	–
<b>Maximum set pressure</b>	-268 to -60 °C	12.1	12.1	20.7	33.1
	-59 to -29 °C	19.0	19.0	36.2	69.0
	-28 to 38 °C	19.0	19.0	36.2	69.0
	232 °C	12.4	19.0	34.1	67.2
	427 °C	5.5	19.0	29.0	58.3
	538 °C	1.4	19.0	24.1	48.3
<b>Outlet pressure limit</b> Conventional design	19.0	19.0	19.0	19.0	–
<b>Outlet pressure limit</b> Balanced bellows design	5.5	5.5	10.3	10.3	–
<b>Body material: WC6 1.7357</b>					
<b>Pressure range p [bar] S/G/L</b>					
<b>Article numbers</b>	–	–	<b>5267.650<sup>o</sup></b>	<b>5267.651<sup>o</sup></b>	<b>5267.652<sup>o</sup></b>
<b>Maximum set pressure</b>	427 °C	–	35.2	69.0	69.0
	538 °C	–	14.8	29.7	44.8
<b>Outlet pressure limit</b> Conventional design	–	–	19.7	19.7	19.7
<b>Outlet pressure limit</b> Balanced bellows design	–	–	10.3	10.3	10.3
<b>Body material: LCB</b>					
<b>Pressure range p [bar] S/G/L</b>					
<b>Article numbers</b>	<b>5263.554<sup>o</sup></b>	<b>5263.555<sup>o</sup></b>	<b>5263.556<sup>o</sup></b>	<b>5263.557<sup>o</sup></b>	<b>5263.558<sup>o</sup></b>
<b>Maximum set pressure</b>	-46 to 38 °C	18.4	18.4	36.2	69.0
	200 °C	13.8	18.4	36.2	69.0
	343 °C	8.4	18.4	36.2	69.0
<b>Outlet pressure limit</b> Conventional design	18.4	18.4	18.4	18.4	18.4
<b>Outlet pressure limit</b> Balanced bellows design	5.5	5.5	10.3	10.3	10.3

<sup>o</sup> Please add code for the required cap or lifting device. See page 11.

Remark: SA 352 Gr. LCB is not listed in the API 526. Pressure-Temperature Rating acc. to ASME B16.34 Table 2-1.3  
The stated Pressure-Temperature Rating are taken from ASME B16.34 Table 2-1.3 if the maximum pressure is not limited by API 526.

Due to the extended material test certificate the LESER LCB can be applied as LCC, WCB, WCC and 1.0619 with the respective pressure-temperature range as well.

## Type 526

### Orifice P

#### Pressure temperature ratings

#### US units

Valve size	4 P 6	4 P 6	4 P 6	4 P 6	4 P 6
Flange rating class <small>Inlet x Outlet</small>	150 x 150	300L x 150	300 x 150	600 x 150	900 x 150
Actual Orifice diameter $d_0$ [inch]	3.15	3.15	3.15	3.15	3.15
Actual Orifice area $A_0$ [inch <sup>2</sup> ]	7.79	7.79	7.79	7.79	7.79
Minimum set pressure [psig] S/G/L	2.0	2.0	4.0	4.0	4.0
Minimum set pressure [psig] S/G	33.4	33.4	33.4	33.4	33.4
Balanced bellows Inconel [psig] L	36.3	36.3	36.3	36.3	36.3
<b>Body material: WCB 1.0619</b>					
<b>Pressure range p [psig] S/G/L</b>					
<b>Article numbers</b>	<b>5262.645<sup>o</sup></b>	<b>5262.646<sup>o</sup></b>	<b>5262.647<sup>o</sup></b>	<b>5262.648<sup>o</sup></b>	<b>5262.649<sup>o</sup></b>
<b>Maximum set pressure</b>	-20 to 100 °F	285	285	525	1000
	450 °F	185	285	525	1000
	800 °F	80	285	410	825
<b>Outlet pressure limit</b> Conventional design	285	285	285	285	285
<b>Outlet pressure limit</b> Balanced bellows design	80	80	150	150	150
<b>Body material: CF8M 1.4408</b>					
<b>Pressure range p [psig] S/G/L</b>					
<b>Article numbers</b>	<b>5264.653<sup>o</sup></b>	<b>5264.654<sup>o</sup></b>	<b>5264.655<sup>o</sup></b>	<b>5264.656<sup>o</sup></b>	<b>-</b>
<b>Maximum set pressure</b>	-450 to -76 °F	175	175	300	480
	-75 to -21 °F	275	275	525	1000
	-20 to 100 °F	275	275	525	1000
	450 °F	180	275	495	975
	800 °F	80	275	420	845
	1000 °F	20	275	350	700
<b>Outlet pressure limit</b> Conventional design	275	275	275	275	-
<b>Outlet pressure limit</b> Balanced bellows design	80	80	150	150	-
<b>Body material: WC6 1.7357</b>					
<b>Pressure range p [psig] S/G/L</b>					
<b>Article numbers</b>	<b>-</b>	<b>-</b>	<b>5267.650<sup>o</sup></b>	<b>5267.651<sup>o</sup></b>	<b>5267.652<sup>o</sup></b>
<b>Maximum set pressure</b>	800 °F	-	510	1000	1000
	1000 °F	-	215	430	650
<b>Outlet pressure limit</b> Conventional design	-	-	285	285	285
<b>Outlet pressure limit</b> Balanced bellows design	-	-	150	150	150
<b>Body material: LCB</b>					
<b>Pressure range p [psig] S/G/L</b>					
<b>Article numbers</b>	<b>5263.554<sup>o</sup></b>	<b>5263.555<sup>o</sup></b>	<b>5263.556<sup>o</sup></b>	<b>5263.557<sup>o</sup></b>	<b>5263.558<sup>o</sup></b>
<b>Maximum set pressure</b>	-50 to 100 °F	265	265	525	1000
	400 °F	200	265	525	1000
	650 °F	125	265	525	1000
<b>Outlet pressure limit</b> Conventional design	265	265	265	265	265
<b>Outlet pressure limit</b> Balanced bellows design	80	80	150	150	150

<sup>o</sup>) Please add code for the required cap or lifting device. See page 11.

Remark: SA 352 Gr. LCB is not listed in the API 526. Pressure-Temperature Rating acc. to ASME B16.34 Table 2-1.3  
The stated Pressure-Temperature Rating are taken from ASME B16.34 Table 2-1.3 if the maximum pressure is not limited by API 526.

Due to the extended material test certificate the LESER LCB can be applied as LCC, WCB, WCC and 1.0619 with the respective pressure-temperature range as well.

## Type 526

### Orifice Q

#### Pressure temperature ratings

#### Metric units

Valve size	6 Q 8	6 Q 8	6 Q 8	6 Q 8	
Flange rating class <small>Inlet x Outlet</small>	150 x 150	300L x 150	300 x 150	600 x 150	
Actual Orifice diameter $d_0$ [mm]	105.5	105.5	105.5	105.5	
Actual Orifice area $A_0$ [mm <sup>2</sup> ]	8742	8742	8742	8742	
Minimum set pressure [bar] S/G/L	0.2	0.2	0.2	0.2	
Minimum set pressure [bar] S/G	1.3	1.3	1.3	1.3	
Balanced bellows Inconel [bar] L	2.3	2.3	2.3	2.3	
<b>Body material: WCB 1.0619</b>		<b>Pressure range p [bar] S/G/L</b>			
<b>Article numbers</b>	<b>5262.657<sup>Ⓜ</sup></b>	Use 6 Q 8 300 x 150	<b>5262.658<sup>Ⓜ</sup></b>	<b>5262.659<sup>Ⓜ</sup></b>	
<b>Maximum set pressure</b>	-29 to 38 °C		11.4	20.7	41.4 (70)
	232 °C		11.4	20.7	41.4 (70)
	427 °C		5.5	20.7	41.4 (56.9)
<b>Outlet pressure limit</b> Conventional design	7.9		7.9	7.9	7.9
<b>Outlet pressure limit</b> Balanced bellows design	4.8	7.9	7.9	7.9	
<b>Body material: CF8M 1.4408</b>		<b>Pressure range p [bar] S/G/L</b>			
<b>Article numbers</b>	<b>5264.662<sup>Ⓜ</sup></b>	Use 6 Q 8 300 x 150	<b>5264.663<sup>Ⓜ</sup></b>	<b>5264.664<sup>Ⓜ</sup></b>	
<b>Maximum set pressure</b>	-268 to -60 °C		11.4	17.2	20.7
	-59 to -29 °C		11.4	20.7	41.4
	-28 to 38 °C		11.4	20.7	41.4
	232 °C		11.4	20.7	41.4
	427 °C		5.5	20.7	41.4
538 °C	1.4		20.7	41.4	
<b>Outlet pressure limit</b> Conventional design	7.9	7.9	7.9	7.9	
<b>Outlet pressure limit</b> Balanced bellows design	4.8	7.9	7.9	7.9	
<b>Body material: WC6 1.7357</b>		<b>Pressure range p [bar] S/G/L</b>			
<b>Article numbers</b>	-	Use 6 Q 8 300 x 150	<b>5267.660<sup>Ⓜ</sup></b>	<b>5267.661<sup>Ⓜ</sup></b>	
<b>Maximum set pressure</b>	427 °C		-	11.4	41.4 (70)
	538 °C		-	11.4	29.7 (29.7)
<b>Outlet pressure limit</b> Conventional design	-		7.9	7.9	7.9
<b>Outlet pressure limit</b> Balanced bellows design	-	7.9	7.9	7.9	
<b>Body material: LCB</b>		<b>Pressure range p [bar] S/G/L</b>			
<b>Article numbers</b>	<b>5263.559<sup>Ⓜ</sup></b>	Use 6 Q 8 300 x 150	<b>5263.560<sup>Ⓜ</sup></b>	<b>5263.561<sup>Ⓜ</sup></b>	
<b>Maximum set pressure</b>	-46 to 38 °C		11.4	20.7	41.4 (70)
	200 °C		11.4	20.7	41.4 (70)
	343 °C		8.4	20.7	41.4 (70)
<b>Outlet pressure limit</b> Conventional design	7.9		7.9	7.9	7.9
<b>Outlet pressure limit</b> Balanced bellows design	4.8	7.9	7.9	7.9	

<sup>Ⓜ</sup>) Please add code for the required cap or lifting device. See page 11.

( ) = maximum set pressure of Type 526 high pressure design (Option code Z90)

Remark: SA 352 Gr. LCB is not listed in the API 526. Pressure-Temperature Rating acc. to ASME B16.34 Table 2-1.3  
The stated Pressure-Temperature Rating are taken from ASME B16.34 Table 2-1.3 if the maximum pressure is not limited by API 526.

Due to the extended material test certificate the LESER LCB can be applied as LCC, WCB, WCC and 1.0619 with the respective pressure-temperature range as well.



## Type 526

### Orifice Q

#### Pressure temperature ratings

#### US units

Valve size	6 Q 8	6 Q 8	6 Q 8	6 Q 8	
Flange rating class <small>Inlet x Outlet</small>	150 x 150	300L x 150	300 x 150	600 x 150	
Actual Orifice diameter $d_0$ [inch]	4.15	4.15	4.15	4.15	
Actual Orifice area $A_0$ [inch <sup>2</sup> ]	13.55	13.55	13.55	13.55	
Minimum set pressure [psig] S/G/L	3.0	3.0	3.0	3.0	
Minimum set pressure [psig] S/G	18.8	18.8	18.8	18.8	
Balanced bellows Inconel [psig] F	33.4	33.4	33.4	33.4	
<b>Body material: WCB 1.0619</b>		<b>Pressure range p [psig] S/G/L</b>			
<b>Article numbers</b>	<b>5262.657<sup>Ⓜ</sup></b>	Use 6 Q 8 300 x 150	<b>5262.658<sup>Ⓜ</sup></b>	<b>5262.659<sup>Ⓜ</sup></b>	
<b>Maximum set pressure</b>	-20 to 100 °F		165	300	600 (1015)
	450 °F		165	300	600 (1015)
	800 °F		80	300	600 (825)
<b>Outlet pressure limit</b> Conventional design	115		115	115	115
<b>Outlet pressure limit</b> Balanced bellows design	70	115	115	115	
<b>Body material: CF8M 1.4408</b>		<b>Pressure range p [psig] S/G/L</b>			
<b>Article numbers</b>	<b>5264.662<sup>Ⓜ</sup></b>	Use 6 Q 8 300 x 150	<b>5264.663<sup>Ⓜ</sup></b>	<b>5264.664<sup>Ⓜ</sup></b>	
<b>Maximum set pressure</b>	-450 to -76 °F		165	250	300
	-75 to -21 °F		165	300	600
	-20 to 100 °F		165	300	600
	450 °F		165	300	600
	800 °F		80	300	600
	1000 °F		20	300	600
<b>Outlet pressure limit</b> Conventional design	115	115	115	115	
<b>Outlet pressure limit</b> Balanced bellows design	70	115	115	115	
<b>Body material: WC6 1.7357</b>		<b>Pressure range p [psig] S/G/L</b>			
<b>Article numbers</b>	–	Use 6 Q 8 300 x 150	<b>5267.660<sup>Ⓜ</sup></b>	<b>5267.661<sup>Ⓜ</sup></b>	
<b>Maximum set pressure</b>	800 °F		–	165	600 (1015)
	1000 °F		–	165	430 (430)
<b>Outlet pressure limit</b> Conventional design	–		115	115	115
<b>Outlet pressure limit</b> Balanced bellows design	–	115	115	115	
<b>Body material: LCB</b>		<b>Pressure range p [psig] S/G/L</b>			
<b>Article numbers</b>	<b>5263.559<sup>Ⓜ</sup></b>	Use 6 Q 8 300 x 150	<b>5263.560<sup>Ⓜ</sup></b>	<b>5263.561<sup>Ⓜ</sup></b>	
<b>Maximum set pressure</b>	-50 to 100 °F		165	300	600 (1015)
	400 °F		165	300	600 (1015)
	650 °F		125	300	600 (1015)
<b>Outlet pressure limit</b> Conventional design	115		115	115	115
<b>Outlet pressure limit</b> Balanced bellows design	70	115	115	115	

<sup>Ⓜ</sup>) Please add code for the required cap or lifting device. See page 11.

( ) = maximum set pressure of Type 526 high pressure design (Option code Z90)

Remark: SA 352 Gr. LCB is not listed in the API 526. Pressure-Temperature Rating acc. to ASME B16.34 Table 2-1.3  
The stated Pressure-Temperature Rating are taken from ASME B16.34 Table 2-1.3 if the maximum pressure is not limited by API 526.

Due to the extended material test certificate the LESER LCB can be applied as LCC, WCB, WCC and 1.0619 with the respective pressure-temperature range as well.

## Type 526

### Orifice R

#### Pressure temperature ratings

#### Metric units

Valve size	6 R 8	6 R 8	6 R 10	6 R 10
Flange rating class <small>Inlet x Outlet</small>	150 x 150	300L x 150	300 x 150	600 x 150
Actual Orifice diameter $d_0$ [mm]	126.0	126.0	126.0	126.0
Actual Orifice area $A_0$ [mm <sup>2</sup> ]	12568	12568	12568	12568
Minimum set pressure [bar] S/G/L	0.2	0.2	0.2	0.2
Minimum set pressure [bar] S/G	1.0	1.0	3.0	3.0
Balanced bellows Inconel [bar] L	1.4	1.4	3.0	3.0
<b>Body material: WCB 1.0619</b>		<b>Pressure range p [bar] S/G/L</b>		
<b>Article numbers</b>	<b>5262.665<sup>Ⓜ</sup></b>	<b>5262.666<sup>Ⓜ</sup></b>	<b>5262.667<sup>Ⓜ</sup></b>	<b>5262.668<sup>Ⓜ</sup></b>
<b>Maximum</b>	-29 to 38 °C	6.9	6.9	15.9
<b>Set pressure</b>	232 °C	6.9	6.9	15.9
	427 °C	5.5	6.9	15.9
<b>Outlet pressure limit</b>		4.1	4.1	6.9
Conventional design				6.9
<b>Outlet pressure limit</b>		4.1	4.1	6.9
Balanced bellows design				6.9
<b>Body material: CF8M 1.4408</b>		<b>Pressure range p [bar] S/G/L</b>		
<b>Article numbers</b>	<b>5264.671<sup>Ⓜ</sup></b>	<b>5264.672<sup>Ⓜ</sup></b>	<b>5264.673<sup>Ⓜ</sup></b>	<b>5264.674<sup>Ⓜ</sup></b>
<b>Maximum</b>	-268 to -60 °C	3.8	3.8	10.3
<b>Set pressure</b>	-59 to -29 °C	6.9	6.9	15.9
	-28 to 38 °C	6.9	6.9	15.9
	232 °C	6.9	6.9	15.9
	427 °C	5.5	6.9	15.9
	538 °C	1.4	6.9	15.9
<b>Outlet pressure limit</b>		4.1	4.1	6.9
Conventional design				6.9
<b>Outlet pressure limit</b>		4.1	4.1	6.9
Balanced bellows design				6.9
<b>Body material: WC6 1.7357</b>		<b>Pressure range p [bar] S/G/L</b>		
<b>Article numbers</b>	-	<b>5267.669<sup>Ⓜ</sup></b>	-	<b>5267.670<sup>Ⓜ</sup></b>
<b>Maximum</b>	427 °C	-	6.9	-
<b>Set pressure</b>	538 °C	-	6.9	-
<b>Outlet pressure limit</b>		-	4.1	-
Conventional design				6.9
<b>Outlet pressure limit</b>		-	4.1	-
Balanced bellows design				6.9
<b>Body material: LCB</b>		<b>Pressure range p [bar] S/G/L</b>		
<b>Article numbers</b>	<b>5263.562<sup>Ⓜ</sup></b>	<b>5263.563<sup>Ⓜ</sup></b>	<b>5263.564<sup>Ⓜ</sup></b>	<b>5263.565<sup>Ⓜ</sup></b>
<b>Maximum</b>	-46 to 38 °C	6.9	6.9	15.9
<b>Set pressure</b>	200 °C	6.9	6.9	15.9
	343 °C	6.9	6.9	15.9
<b>Outlet pressure limit</b>		4.1	4.1	6.9
Conventional design				6.9
<b>Outlet pressure limit</b>		4.1	4.1	6.9
Balanced bellows design				6.9

<sup>Ⓜ</sup>) Please add code for the required cap or lifting device. See page 11.

( ) = maximum set pressure of Type 526 high pressure design (Option code Z90)

Remark: SA 352 Gr. LCB is not listed in the API 526. Pressure-Temperature Rating acc. to ASME B16.34 Table 2-1.3  
The stated Pressure-Temperature Rating are taken from ASME B16.34 Table 2-1.3 if the maximum pressure is not limited by API 526.

Due to the extended material test certificate the LESER LCB can be applied as LCC, WCB, WCC and 1.0619 with the respective pressure-temperature range as well.

## Type 526

### Orifice R

#### Pressure temperature ratings

#### US units

Valve size	6 R 8	6 R 8	6 R 10	6 R 10
Flange rating class <small>Inlet x Outlet</small>	150 x 150	300L x 150	300 x 150	600 x 150
Actual Orifice diameter $d_0$ [inch]	4.96	4.96	4.96	4.96
Actual Orifice area $A_0$ [inch <sup>2</sup> ]	19.33	19.33	19.33	19.33
Minimum set pressure [psig] S/G/L	3.0	3.0	3.0	3.0
Minimum set pressure [psig] S/G	14.5	14.5	43.5	43.5
Balanced bellows Inconel [psig] L	20.3	20.3	43.5	43.5
<b>Body material: WCB 1.0619</b>				
<b>Pressure range p [psig] S/G/L</b>				
<b>Article numbers</b>	<b>5262.665<sup>Ⓜ</sup></b>	<b>5262.666<sup>Ⓜ</sup></b>	<b>5262.667<sup>Ⓜ</sup></b>	<b>5262.668<sup>Ⓜ</sup></b>
<b>Maximum Set pressure</b>				
-20 to 100 °F	100	100	230	300 (913.5)
450 °F	100	100	230	300 (913.5)
800 °F	80	100	230	300 (825)
<b>Outlet pressure limit</b> Conventional design	60	60	100	100
<b>Outlet pressure limit</b> Balanced bellows design	60	60	100	100
<b>Body material: CF8M 1.4408</b>				
<b>Pressure range p [psig] S/G/L</b>				
<b>Article numbers</b>	<b>5264.671<sup>Ⓜ</sup></b>	<b>5264.672<sup>Ⓜ</sup></b>	<b>5264.673<sup>Ⓜ</sup></b>	<b>5264.674<sup>Ⓜ</sup></b>
<b>Maximum Set pressure</b>				
-450 to -76 °F	55	55	150	200
-75 to -21 °F	100	100	230	300
-20 to 100 °F	100	100	230	300
450 °F	100	100	230	300
800 °F	80	100	230	300
1000 °F	20	100	230	300
<b>Outlet pressure limit</b> Conventional design	60	60	100	100
<b>Outlet pressure limit</b> Balanced bellows design	60	60	100	100
<b>Body material: WC6 1.7357</b>				
<b>Pressure range p [psig] S/G/L</b>				
<b>Article numbers</b>	–	<b>5267.669<sup>Ⓜ</sup></b>	–	<b>5267.670<sup>Ⓜ</sup></b>
<b>Maximum Set pressure</b>				
800 °F	–	100	–	300 (913.5)
1000 °F	–	100	–	300 (430)
<b>Outlet pressure limit</b> Conventional design	–	60	–	100
<b>Outlet pressure limit</b> Balanced bellows design	–	60	–	100
<b>Body material: LCB</b>				
<b>Pressure range p [psig] S/G/L</b>				
<b>Article numbers</b>	<b>5263.562<sup>Ⓜ</sup></b>	<b>5263.563<sup>Ⓜ</sup></b>	<b>5263.564<sup>Ⓜ</sup></b>	<b>5263.565<sup>Ⓜ</sup></b>
<b>Maximum Set pressure</b>				
-50 to 100 °F	100	100	230	300 (913.5)
400 °F	100	100	230	300 (913.5)
650 °F	100	100	230	300 (913.5)
<b>Outlet pressure limit</b> Conventional design	60	60	100	100
<b>Outlet pressure limit</b> Balanced bellows design	60	60	100	100

<sup>Ⓜ</sup> Please add code for the required cap or lifting device. See page 11.

( ) = maximum set pressure of Type 526 high pressure design (Option code Z90)

Remark: SA 352 Gr. LCB is not listed in the API 526. Pressure-Temperature Rating acc. to ASME B16.34 Table 2-1.3  
The stated Pressure-Temperature Rating are taken from ASME B16.34 Table 2-1.3 if the maximum pressure is not limited by API 526.

Due to the extended material test certificate the LESER LCB can be applied as LCC, WCB, WCC and 1.0619 with the respective pressure-temperature range as well.

## Type 526

### Orifice T

#### Pressure temperature ratings

#### Metric units

Valve size	8 T 10	8 T 10	8 T 10
Flange rating class <small>Inlet x Outlet</small>	150 x 150	300L x 150	300 x 150
Actual Orifice diameter $d_0$ [mm]	161.5	161.5	161.5
Actual Orifice area $A_0$ [mm <sup>2</sup> ]	20485	20485	20485
Minimum set pressure [bar] S/G/L	0.25	0.25	0.25
Minimum set pressure [bar] S/G	1.2	1.2	1.2
Balanced bellows Inconel [bar] L	2.5	2.5	2.5
<b>Body material: WCB 1.0619</b>		<b>Pressure range p [bar] S/G/L</b>	
<b>Article numbers</b>	<b>5262.675<sup>Ⓜ</sup></b>	Use 8 T 10 300 x 150	<b>5262.676<sup>Ⓜ</sup></b>
<b>Maximum set pressure</b>			
-29 to 38 °C	4.5		20.7 (36)
232 °C	4.5		20.7 (36)
427 °C	4.5		20.7 (28.3)
<b>Outlet pressure limit</b>			
Conventional design	2.1	6.9	
<b>Outlet pressure limit</b>			
Balanced bellows design	2.1	6.9	
<b>Body material: CF8M 1.4408</b>		<b>Pressure range p [bar] S/G/L</b>	
<b>Article numbers</b>	<b>5264.678<sup>Ⓜ</sup></b>	Use 8 T 10 300 x 150	<b>5264.679<sup>Ⓜ</sup></b>
<b>Maximum set pressure</b>			
-268 to -60 °C	3.4		4.5
-59 to -29 °C	4.5		8.3
-28 to 38 °C	4.5		8.3
232 °C	4.5		8.3
427 °C	4.5		8.3
538 °C	1.4		8.3
<b>Outlet pressure limit</b>			
Conventional design	2.1	4.1	
<b>Outlet pressure limit</b>			
Balanced bellows design	2.1	4.1	
<b>Body material: WC6 1.7357</b>		<b>Pressure range p [bar] S/G/L</b>	
<b>Article numbers</b>	-	Use 8 T 10 300 x 150	<b>5267.677<sup>Ⓜ</sup></b>
<b>Maximum Set pressure</b>			
427 °C	-		20.7 (35.2)
538 °C	-		15.5 (15.5)
<b>Outlet pressure limit</b>			
Conventional design	-	6.9	
<b>Outlet pressure limit</b>			
Balanced bellows design	-	6.9	
<b>Body material: LCB</b>		<b>Pressure range p [bar] S/G/L</b>	
<b>Article numbers</b>	<b>5263.566<sup>Ⓜ</sup></b>	Use 8 T 10 300 x 150	<b>5263.567<sup>Ⓜ</sup></b>
<b>Maximum set pressure</b>			
-46 to 38 °C	4.5		20.7 (36)
200 °C	4.5		20.7 (36)
343 °C	4.5		20.7 (36)
<b>Outlet pressure limit</b>			
Conventional design	2.1	6.9	
<b>Outlet pressure limit</b>			
Balanced bellows design	2.1	6.9	

<sup>Ⓜ</sup>) Please add code for the required cap or lifting device. See page 11.

( ) = maximum set pressure of Type 526 high pressure design (Option code Z90)

Remark: SA 352 Gr. LCB is not listed in the API 526. Pressure-Temperature Rating acc. to ASME B16.34 Table 2-1.3  
The stated Pressure-Temperature Rating are taken from ASME B16.34 Table 2-1.3 if the maximum pressure is not limited by API 526.

Due to the extended material test certificate the LESER LCB can be applied as LCC, WCB, WCC and 1.0619 with the respective pressure-temperature range as well.

## Type 526

### Orifice T

#### Pressure temperature ratings

#### US units

Valve size	8 T 10	8 T 10	8 T 10	
Flange rating class <small>Inlet x Outlet</small>	150 x 150	300L x 150	300 x 150	
Actual Orifice diameter $d_0$ [inch]	6.36	6.36	6.36	
Actual Orifice area $A_0$ [inch <sup>2</sup> ]	31.75	31.75	31.75	
Minimum set pressure [psig] S/G/L	4.0	4.0	4.0	
Minimum set pressure [psig] S/G	17.4	17.4	17.4	
Balanced bellows Inconel [psig] L	36.3	36.3	36.3	
<b>Body material: WCB 1.0619</b>		<b>Pressure range p [psig] S/G/L</b>		
<b>Article numbers</b>	<b>5262.675<sup>o</sup></b>	Use 8 T 10 300 x 150	<b>5262.676<sup>o</sup></b>	
<b>Maximum set pressure</b>	-20 to 100 °F		65	300 (522)
	450 °F		65	300 (522)
	800 °F		65	300 (410)
<b>Outlet pressure limit</b>	Conventional design		30	100
<b>Outlet pressure limit</b>	Balanced bellows design		30	100
<b>Body material: CF8M 1.4408</b>		<b>Pressure range p [psig] S/G/L</b>		
<b>Article numbers</b>	<b>5264.678<sup>o</sup></b>	Use 8 T 10 300 x 150	<b>5264.679<sup>o</sup></b>	
<b>Maximum set pressure</b>	-450 to -76 °F		50	65
	-75 to -21 °F		65	120
	-20 to 100 °F		65	120
	450 °F		65	120
	800 °F		65	120
	1000 °F		20	120
<b>Outlet pressure limit</b>	Conventional design	30	60	
<b>Outlet pressure limit</b>	Balanced bellows design	30	60	
<b>Body material: WC6 1.7357</b>		<b>Pressure range p [psig] S/G/L</b>		
<b>Article numbers</b>	-	Use 8 T 10 300 x 150	<b>5267.677<sup>o</sup></b>	
<b>Maximum set pressure</b>	800 °F		-	300 (510)
	1000 °F		-	225 (225)
<b>Outlet pressure limit</b>	Conventional design		-	100
<b>Outlet pressure limit</b>	Balanced bellows design	-	100	
<b>Body material: LCB</b>		<b>Pressure range p [psig] S/G/L</b>		
<b>Article numbers</b>	<b>5263.566<sup>o</sup></b>	Use 8 T 10 300 x 150	<b>5263.567<sup>o</sup></b>	
<b>Maximum set pressure</b>	-50 to 100 °F		65	300 (522)
	400 °F		65	300 (522)
	650 °F		65	300 (522)
<b>Outlet pressure limit</b>	Conventional design		30	100
<b>Outlet pressure limit</b>	Balanced bellows design	30	100	

<sup>o</sup>) Please add code for the required cap or lifting device. See page 11.

( ) = maximum set pressure of Type 526 high pressure design (Option code Z90)

Remark: SA 352 Gr. LCB is not listed in the API 526. Pressure-Temperature Rating acc. to ASME B16.34 Table 2-1.3  
The stated Pressure-Temperature Rating are taken from ASME B16.34 Table 2-1.3 if the maximum pressure is not limited by API 526.

Due to the extended material test certificate the LESER LCB can be applied as LCC, WCB, WCC and 1.0619 with the respective pressure-temperature range as well.

## Type 526 Available options

Type 526

**Screwed cap H2**  
H2



**Packed lever H4**  
H4



**Plain lever H3**  
H3



**Open bonnet**  
See Art. No.



**Test gag**  
J69: H4  
J70: H2  
K05: H1  
K27: H6

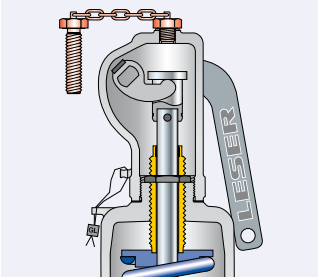

**Lift indicator**  
J39: Adaptor for lift indicator H4  
J93: Lift indicator

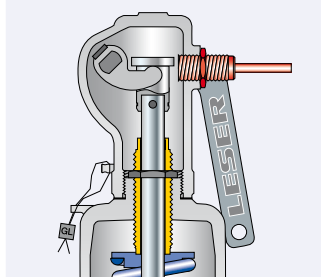

**Bolted cap H1**  
K01

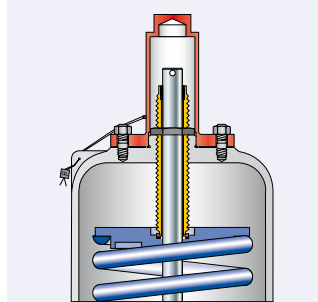

**Bolted lifting device H6**  
K06

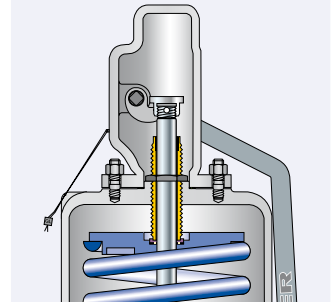

**Flange drillings**  
acc. to DIN EN 1092-1

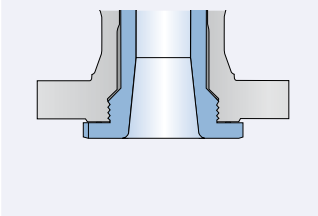

**Outlet flange rating class 300**

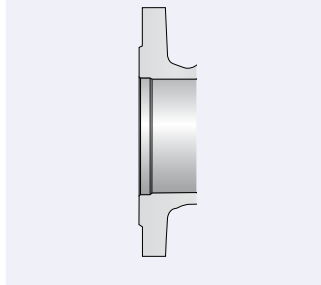

**O-ring disc**  
J21: CR "K"  
J22: EPDM "D"  
J23: FKM "L"  
J20: FFKM "C"



**Disc with inserted sealing plate**  
J44+S07: PTFE-FDA "A"  
J48+S07: PCTFE "G"  
J49+S07: SP "T"

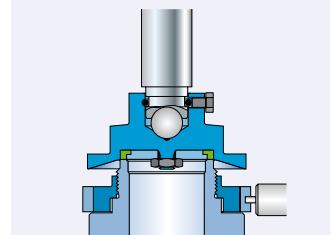

**Inconel bellows**  
J83

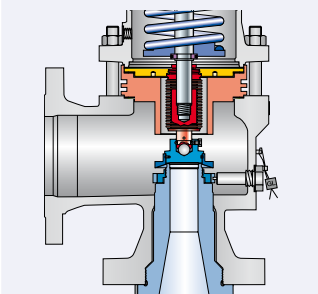

**Bug screen**  
M70

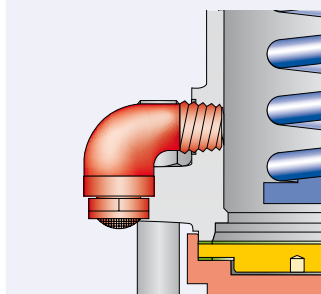

**Conversion kit for balanced bellows**

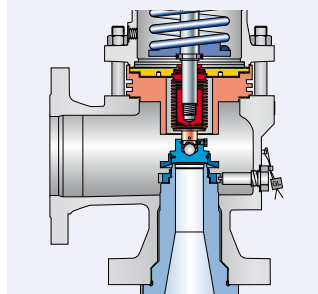

**High temperature equipment**  
J88

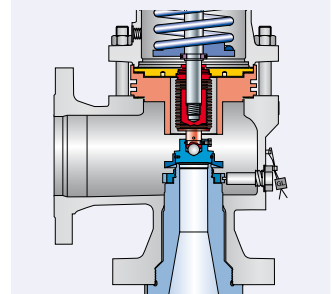

## Type 526 Available options

**NACE sour gas application**  
N78



**INCONEL X-750 spring**  
X08



**API Alloy Concept**

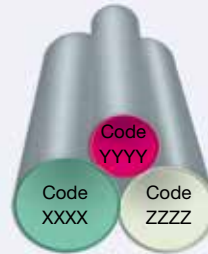

**High pressure design**  
for orifices Q, R, T  
Z90

**Butt-weld connection**  
S05



**Heating jacket**



**LESER Original Spare Parts Kits**  
see page 54



**UREA Synthesis section**  
safety valve



## Type 526

### Flange drillings according to DIN EN 1092-1

Type 526

Standard API 526		Article number					Flange drillings															
Valve size	Flange class	Material				Inlet NPS [DN]	Inlet										Outlet					
		WCB 5262.	LCB 5263.	WC6 5267.	CF8M 5264.		PN 10/16	PN 25	PN 40	PN 63	PN 100	PN 160	PN 250	PN 320	PN 400	NPS [DN]	PN 10	PN 16	PN 25	PN 40	PN 63	
1 D 2	300 x 150 <sup>1)</sup>	002*	501*	006*	011*	25	H47	H47	H47	-	-	-	-	-	-	-	50	H15	H15	H15	H15	-
1 D 2	600 x 150	003*	502*	007*	012*	25	-	-	-	H10	H17	-	-	-	-	-	50	H15	H15	H15	H15	-
1½ D 2	1500 x 300	004*	503*	008*	013*	40	-	-	-	-	-	H11	H12	-	-	-	50	H15	H15	H15	H15	-
1½ D 3	2500 x 300	005*	504*	009*	014*	40	-	-	-	-	-	-	H12	H13	-	-	80	H15	H15	H15	H15	H16
1 E 2	300 x 150 <sup>1)</sup>	016*	506*	020*	025*	25	H47	H47	H47	-	-	-	-	-	-	-	50	H15	H15	H15	H15	-
1 E 2	600 x 150	017*	507*	021*	026*	25	-	-	-	H10	H17	-	-	-	-	-	50	H15	H15	H15	H15	-
1½ E 2	1500 x 300	018*	508*	022*	027*	40	-	-	-	-	-	H11	H12	-	-	-	50	H15	H15	H15	H15	-
1½ E 3	2500 x 300	019*	509*	023*	028*	40	-	-	-	-	-	-	H12	H13	-	-	80	H15	H15	H15	H15	H16
1½ F 2	300L x 150	030*	511*	-	040*	40	H47	-	-	-	-	-	-	-	-	-	50	H15	H15	H15	H15	-
1½ F 2	300 x 150	031*	512*	035*	041*	40	-	H47	H47	-	-	-	-	-	-	-	50	H15	H15	H15	H15	-
1½ F 2	600 x 150	032*	513*	036*	042*	40	-	H47	H47	-	-	-	-	-	-	-	50	H15	H15	H15	H15	-
1½ F 3	1500 x 300	033*	514*	037*	043*	40	-	-	-	H10	H17	H11	H12	-	-	-	80	H15	H15	H15	H15	H16
1½ F 3	2500 x 300	034*	515*	038*	044*	40	-	-	-	-	-	-	H12	H13	-	-	80	H15	H15	H15	H15	H16
1½ G 3	300L x 150	046*	517*	-	111*	40	H47	-	-	-	-	-	-	-	-	-	80	H15	H15	H15	H15	-
1½ G 3	300 x 150	047*	518*	052*	112*	40	-	H47	H47	H10	-	-	-	-	-	-	80	H15	H15	H15	H15	-
1½ G 3	600 x 150	048*	519*	053*	113*	40	-	-	-	H10	H17	H11	-	-	-	-	80	H15	H15	H15	H15	-
1½ G 3	900 x 300	049*	520*	054*	114*	40	-	-	-	-	H17	H11	-	-	-	-	80	H15	H15	H15	H15	H16
2 G 3	1500 x 300	050*	521*	055*	115*	50	-	-	-	-	-	-	H12	H13	-	-	80	H15	H15	H15	H15	H16
2 G 3	2500 x 300	051*	522*	056*	116*	50	-	-	-	-	-	-	-	-	H14	-	80	H15	H15	H15	H15	H16
1½ H 3	300L x 150	143*	524*	-	153*	40	H47	H47	H47	-	-	-	-	-	-	-	80	H15	H15	H15	H15	-
2 H 3	300 x 150	144*	525*	148*	154*	50	-	-	H47	H10	-	-	-	-	-	-	80	H15	H15	H15	H15	-
2 H 3	600 x 150	-	-	149*	-	50	-	-	H47	H10	-	-	-	-	-	-	80	H15	H15	H15	H15	-
2 H 3	600 x 150	145*	526*	-	155*	50	-	-	H47	H10	-	-	-	-	-	-	80	H15	H15	H15	H15	H16
2 H 3	900 x 150	146*	527*	150*	156*	50	-	-	-	-	H17	H11	-	-	-	-	80	H15	H15	H15	H15	H16
2 H 3	1500 x 300	147*	528*	151*	157*	50	-	-	-	-	-	H11	H12	-	-	-	80	H15	H15	H15	H15	H16
2 J 3	300L x 150	163*	530*	-	197*	50	H47	H47	H47	H10	-	-	-	-	-	-	80	H15	H15	H15	H15	-
3 J 4	600 x 150	165*	532*	169*	199*	80	-	-	H47	H10	-	-	-	-	-	-	100	H51	H51	H51	H51	-
3 J 4	900 x 150	166*	533*	170*	200*	80	-	-	-	-	H17	H11	-	-	-	-	100	H51	H51	H15	H15	H16
3 J 4	1500 x 300	167*	534*	171*	201*	80	-	-	-	-	-	H11	H12	-	-	-	100	H51	H51	H15	H15	H16

<sup>1)</sup> 300L x 150 is available with the same Article-No.

Note: Flange drillings and facings meet always the requirements of mentioned flange standards. Flange thickness and outer diameter may be thicker and wider than flange standard. For correct selection of bolting please refer to LDeS 3007.01. The inlet pressure size CL150 is not considered, please switch to inlet pressure size CL300 or CL300L.



## Type 526

### Flange drillings according to DIN EN 1092-1

Standard API 526	Article number	Flange drillings																				
		Material				Inlet	Inlet										Outlet	Outlet				
		WCB	LCB	WC6	CF8M		PN	PN	PN	PN	PN	PN	PN	PN	PN	PN		PN	PN	PN	PN	PN
Valve size	Flange class	5262.	5263.	5267.	5264.	[DN]	10/16	25	40	63	100	160	250	320	400	[DN]	10	16	25	40	63	
3 K 4	300 x 150 <sup>1)</sup>	203*	536*	207*	212*	80	H47	H47	H47	H10	-	-	-	-	-	100	H51	H51	H15	H15	-	
3 K 4	600 x 150	204*	537*	208*	213*	80	-	-	H47	H10	-	-	-	-	-	100	H51	H51	H15	H15	-	
3 K 6	900 x 150	-	-	209*	-	80	-	-	-	H10	H17	H11	H12	-	-	150	H51	H51	-	-	-	
3 K 6	900 x 150	205*	538*	-	214*	80	-	-	-	H10	H17	H11	H12	-	-	150	H51	H51	H15	H15	-	
3 K 6	1500 x 300	206*	539*	210*	215*	80	-	-	-	H10	H17	H11	H12	-	-	150	H51	H51	H15	H15	-	
3 L 4	300L x 150	233*	541*	-	243*	80	H47	H47	H47	H10	-	-	-	-	-	100	H15	H15	H15	H15	-	
4 L 6	300 x 150	234*	542*	238*	244*	100	H45	H47	H47	H10	-	-	-	-	-	150	H51	H51	-	-	-	
4 L 6	600 x 150	235*	543*	239*	245*	100	-	-	-	H10	H17	H11	-	-	-	150	H51	H51	-	-	-	
4 L 6	900 x 150	236*	544*	240*	246*	100	-	-	-	-	H17	H11	-	-	-	150	H51	H51	-	-	-	
4 L 6	1500 x 300	237*	545*	241*	-	100	-	-	-	-	-	-	H12	-	-	150	H51	H51	-	-	-	
4 M 6	300 x 150 <sup>1)</sup>	581*	547*	584*	588*	100	H45	H47	H47	H10	-	-	-	-	-	150	H51	H51	-	-	-	
4 M 6	600 x 150	582*	548*	585*	589*	100	-	-	-	H10	H17	H11	-	-	-	150	H51	H51	-	-	-	
4 M 6	900 x 150	583*	549*	586*	-	100	-	-	-	-	H17	H11	-	-	-	150	H51	H51	-	-	-	
4 N 6	300L x 150 <sup>1)</sup>	591*	551*	594*	598*	100	H45	H47	H47	H10	-	-	-	-	-	150	H51	H51	-	-	-	
4 N 6	600 x 150	592*	552*	595*	599*	100	-	-	-	-	H17	H11	-	-	-	150	H51	H51	-	-	-	
4 N 6	900 x 150	593*	553*	596*	-	100	-	-	-	-	-	-	-	-	-	150	H51	H51	-	-	-	
4 P 6	300L x 150	646*	555*	-	654*	100	H45	H47	H47	-	-	-	-	-	-	150	H51	H51	-	-	-	
4 P 6	300 x 150	647*	556*	550*	655*	100	-	H47	H47	-	-	-	-	-	-	150	H51	H51	-	-	-	
4 P 6	600 x 300	648*	557*	551*	656*	100	-	-	-	H10	H17	-	-	-	-	150	H51	H51	-	-	-	
4 P 6	900 x 300	649*	558*	552*	-	100	-	-	-	-	-	H11	-	-	-	150	H51	H51	-	-	-	
6 Q 8	300 x 150	658*	560*	660*	663*	150	H45	H47	H47	-	-	-	-	-	-	200	H50	H51	H52	-	-	
6 Q 8	600 x 150	659*	561*	661*	664*	150	-	-	-	H10	H17	-	-	-	-	200	H50	H51	H52	-	-	
6 R 8	300L x 150	666*	563*	669*	672*	150	H45	H47	H47	H10	-	-	-	-	-	200	H50	H51	H52	-	-	
6 R 10	300 x 150	667*	564*	-	673*	150	-	-	H47	H10	-	-	-	-	-	250	H50	H51	-	-	-	
6 R 10	600 x 150	668*	565*	670*	674*	150	-	-	H47	H10	H17	-	-	-	-	250	H50	H51	-	-	-	
8 T 10	300 x 150 <sup>1)</sup>	676*	567*	677*	679*	200	-	H46	H47	-	-	-	-	-	-	250	H50	H51	-	-	-	

<sup>1)</sup> 300L x 150 is available with the same Article-No.

Note: Flange drillings and facings meet always the requirements of mentioned flange standards. Flange thickness and outer diameter may be thicker and wider than flange standard. For correct selection of bolting please refer to LDeS 3007.01. The inlet pressure size CL150 is not considered, please switch to inlet pressure size CL300 or CL300L.

## Type 526

### Outlet flange rating class 300

For customer specifications requiring a flange rating class 300 at the outlet LESER provides Type 526 with outlet flange rating class 300. For ordering please state the article numbers and option codes which are listed in the table.

Orifice	Valve size Inlet x Outlet	Body material	300 x 300		600 x 300	
	Center to face a x b		Art. No.	Option code	Art. No.	Option code
D	1" x 2"	WCB 1.0619	5262.002X	H65, H80, S01	5262.003X	H65, H80, S01
		CF8M 1.4408	5264.011X	H65, H80, S01	5264.012X	H65, H80, S01
	4 1/8" x 4 1/2"	WC6 1.7357	5267.006X	H65, H80, S01	5267.007X	H65, H80, S01
		LCB	5263.501X	H65, H80, S01	5263.502X	H65, H80, S01
D	1 1/2" x 2"	WCB 1.0619	5262.004X	H65, H80	5262.004X	H67, H80
		CF8M 1.4408	5264.013X	H65, H80	5264.013X	H67, H80
	4 1/8" x 5 1/2"	WC6 1.7357	5267.008X	H65, H80	5267.008X	H67, H80
		LCB	5263.503X	H65, H80	5263.503X	H67, H80
E	1" x 2"	WCB 1.0619	5262.016X	H65, H80, S01	5262.017X	H65, H80, S01
		CF8M 1.4408	5264.025X	H65, H80, S01	5264.026X	H65, H80, S01
	4 1/8" x 4 1/2"	WC6 1.7357	5267.020X	H65, H80, S01	5267.021X	H65, H80, S01
		LCB	5263.506X	H65, H80, S01	5263.507X	H65, H80, S01
E	1 1/2" x 2"	WCB 1.0619	5262.018X	H65, H80	5262.018X	H67, H80
		CF8M 1.4408	5264.027X	H65, H80	5264.027X	H67, H80
	4 1/8" x 5 1/2"	WC6 1.7357	5267.022X	H65, H80	5267.022X	H67, H80
		LCB	5263.508X	H65, H80	5263.508X	H67, H80
F	1 1/2" x 2"	WCB 1.0619	5262.031X	H65, H80	5262.032X	H67, H80
		CF8M 1.4408	5264.041X	H65, H80	5264.041X	H67, H80
	4 7/8" x 6"	WC6 1.7357	5267.035X	H65, H80	5267.036X	H67, H80
		LCB	5263.512X	H65, H80	5263.512X	H67, H80
G	1 1/2" x 3"	WCB 1.0619	5262.049X	H65, H80	5262.049X	H67, H80
		CF8M 1.4408	5264.114X	H65, H80	5264.114X	H67, H80
	4 7/8" x 6 1/2"	WC6 1.7357	5267.054X	H65, H80	5267.054X	H67, H80
		LCB	5263.520X	H65, H80	5263.520X	H67, H80
H	2" x 3"	WCB 1.0619	5262.146X	H65, H80	5262.146X	H67, H80
		CF8M 1.4408	5264.156X	H65, H80	5264.156X	H67, H80
	6 1/16" x 6 3/8"	WC6 1.7357	5267.150X	H65, H80	5267.150X	H67, H80
		LCB	5263.527X	H65, H80	5263.527X	H67, H80
J	3" x 4"	WCB 1.0619	5262.166X	H65, H80	5262.166X	H67, H80
		CF8M 1.4408	5264.200X	H65, H80	5264.200X	H67, H80
	7 1/4" x 7 1/8"	WC6 1.7357	5267.170X	H65, H80	5267.170X	H67, H80
		LCB	5263.533X	H65, H80	5263.533X	H67, H80

**Grey marked safety valves:** The center to face dimensions are equal to API standard 526 with outlet flange rating class 150.

## Type 526

### Outlet flange rating class 300

Orifice	Valve size Inlet x Outlet	Body material	300 x 300		600 x 300	
	Center to face a x b		Art. No.	Option code	Art. No.	Option code
K	3" x 4"	WCB 1.0619	5262.204X	H65, H80	5262.204X	H67, H80
		CF8M 1.4408	5264.213X	H65, H80	5264.213X	H67, H80
	7 1/4" x 7 1/8"	WC6 1.7357	5267.208X	H65, H80	5267.209X	H67, H80
		LCB	5263.537X	H65, H80	5263.537X	H67, H80
L	4" x 6"	WCB 1.0619	5262.235X	H65, H80	5262.235X	H67, H80
		CF8M 1.4408	5264.245X	H65, H80	5264.245X	H67, H80
	7 3/4" x 8 1/2"	WC6 1.7357	5267.239X	H65, H80	5267.239X	H67, H80
		LCB	5263.543X	H65, H80	5263.543X	H67, H80
M	4" x 6"	WCB 1.0619	5262.582X	H65, H80	5262.582X	H67, H80
		CF8M 1.4408	5264.589X	H65, H80	5264.589X	H67, H80
	7 3/4" x 8 1/2"	WC6 1.7357	5267.585X	H65, H80	5267.585X	H67, H80
		LCB	5263.548X	H65, H80	5263.548X	H67, H80
N	4" x 6"	WCB 1.0619	5262.592X	H65, H80	5262.592X	H67, H80
		CF8M 1.4408	5264.599X	H65, H80	5264.599X	H67, H80
	7 3/4" x 8 1/2"	WC6 1.7357	5267.595X	H65, H80	5267.595X	H67, H80
		LCB	5263.552X	H65, H80	5263.552X	H67, H80
P	4" x 6" Welded outlet flange	WCB 1.0619	5262.647X	S01	5262.648X	S01
		CF8M 1.4408	5264.655X	S01	5262.656X	S01
	8 7/8" x 11 5/8"	WC6 1.7357	5267.650X	S01	5262.651X	S01
		LCB	5263.556X	S01	5262.557X	S01
Q	6" x 8" Welded outlet flange	WCB 1.0619	5262.658X	S01	5262.658X	S01
		CF8M 1.4408	5264.663X	S01	5264.663X	S01
	9 7/16" x 12"	WC6 1.7357	5267.660X	S01	5267.660X	S01
		LCB	5263.560X	S01	5263.560X	S01
R	6" x 10" Welded outlet flange	WCB 1.0619	5262.667X	S01	5262.667X	S01
		CF8M 1.4408	5264.673X	S01	5264.673X	S01
	9 7/16" x 13 1/5"	WC6 1.7357	5267.670X	S01	5267.670X	S01
		LCB	5263.564X	S01	5263.564X	S01
T	8" x 10" Welded outlet flange	WCB 1.0619	5262.676X	S01		
		CF8M 1.4408	5264.679X	S01		
	10 7/8" x 13 1/5"	WC6 1.7357	5267.677X	S01		
		LCB	5263.567X	S01		

**Type 526**

**Outlet flange rating class 300**

Type 526

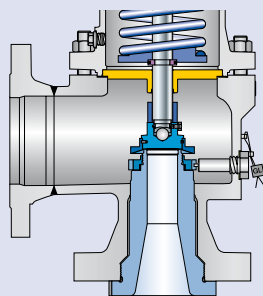
Orifice	900 x 300		1500 x 300		2500 x 300							
	Art. No.	Option code	Art. No.	Option code	Art. No.	Option code						
D	Outlet flange rating class 300 is standard flange rating class acc. to API standard 526											
D												
E												
E												
F												
G												
H							5262.147X	Class 1500 x 300				
							5264.157X					
							5267.151X					
							5263.528X					
J	5262.166X	H68, H80										
	5264.200X	H68, H80										
	5267.170X	H68, H80										
	5263.533X	H68, H80										
K	5262.204X	H68, H80										
	5264.213X	H68, H80										
	5267.209X	H68, H80										
	5263.537X	H68, H80										
L	Welded outlet flange rating class 300 available on request.											
M			<b>Design details</b> <b>Orifice D and E:</b> 1 D 2 and 1 E 2 class 300 x 300 and 600 x 300 are realised by a modification of Type 458 DN 25 / 1". <b>Orifice L:</b> 4 L 6 class 900 x 300 and 1500 x 300 can be realised by a welded outlet flange on request. <b>Orifice M – P:</b> 4 M 6, 4 N 6 and 4 P 6 class 900 x 300 can be realised by a welded outlet flange on request. <b>Orifice P – T:</b> 4 P 6 up to 8 T 10 are realised by a welded outlet flange class 300. <b>Center to face:</b> The center to face dimensions a and b for LESER Type 526 with outlet flange rating class 300 are not specified in API Standard 526. The actual dimensions are listed in the table. They differ from the dimensions which are specified in API 526 for safety valves with outlet flange class 150. Exceptions see page 50.									
N												
P												
Q												
T												

## Type 526

### Flange facings

Acc. to DIN EN 1092						
Flange facing (see also WI 3313.40)		Inlet		Outlet		Remark
		PN 10 – PN 40	PN 63 – PN 400	PN 10 – PN 40	PN 63	
Raised face	Type B1	*	–	*	–	Facing: Rz = 12.5 – 50
	Type B2	L36	*	L38	*	Facing: Rz = 3.2 – 12.5
Tongue face C <sup>1)</sup>		S05		H92		
Groove face D <sup>1)</sup>		S05		H91		
Male face E		S05		H98		
Female face F		S05		H99		
O-ring male face G		S05		S01		
O-ring female face H		S05		S01		

Acc. to ASME B16.5													
Body material	Inlet	Outlet	Smooth finish <sup>2)</sup>		Serrated finish		RTJ-Groove						
			Inlet	Outlet	Inlet	Outlet	Inlet					Outlet	
			Option code	Option code	CL300	CL600	CL900	CL1500	CL2500	CL150	CL300		
All	All	All	L52	L53	*	*	L58					H63	

<sup>1)</sup> LESER manufactures the groove at flanged valves by milling. If a customer demands a turned surface in the soil of the groove according to DIN 2512 and / or DIN EN 1092-1 an additional option code is necessary: "S01: bottom of the groove drilled". <sup>2)</sup> Smooth finish is not defined in the effective standards.

Note: Flange drillings and facings meet always the requirements of mentioned flange standards.  
Flange thickness and outer diameter may vary from flange standard.

**Stud-bolts length for flange connection inlet and outlet**

All LESER safety valves Type 526 need at the inlet side longer stud-bolts for the flange connections as stated in ASME B16.5, due to the full nozzle design. Furthermore, due to the actual castings the stud bolts at the outlet can differ from ASME B16.5 as well. LESER state the stud-bolt length in LDeS 3001.29. For calculation of stud-bolts length the measure "s" stated on page 12 – 15 can be used.

Connection acc. to API Standard 526 – 1984					
Orifice	Valve size		Flange rating class		Option code
	Inlet	Outlet	Inlet		
D / E	1 1/2"	3", drilled 2 1/2"	CL2500		S01
F	1 1/2"	3", drilled 2 1/2"	CL900		S01
G	1 1/2"	3", drilled 2 1/2"	CL150 – 900		S01
J	2 1/2"	4"	CL900 – 1500		S01
K	2 1/2"	6"	CL900 – 1500		S01

General information concerning flange drillings and flange facings	
<b>Dimensions</b>	Flange dimensions of LESER Type 526 exceed flange dimension as mentioned in ASME / ANSI B16.5 and DIN EN 1092. This exceedance is in accordance with API Standard 526, Section 2.4. Dimensions: "For some valve designs, the inlet raised face height may substantially exceed the nominal dimension specified in ASME / ANSI B16.5 (and DIN EN 1092). Consult the manufacturer for exact dimension." The reason for this exceedance is: – height of nozzle placed in the inlet of valve – due to the outer diameter of the nozzle thread flange thickness has to be thicker than normal ASME / ANSI B16.5 and DIN EN 1092 dimension to achieve the required pressure rating
<b>Multiple pressure rating</b>	The flange standard shows the same drilling, facing and outer diameter for several pressure ratings, e.g. PN 16 up to PN 40. Due to the pressure rating of the casting LESER fulfills the requirements for flange thickness e.g. of PN 16 but not PN 40.
<b>Smooth Finish</b>	The effective MSS SP-6 (Edition 2001) does not mention "smooth finish" anymore. In MSS SP-6 (Edition 1980) "smooth finish" is defined for finishes of contact flanges as "250 µinch (6.3 µm) AARH max." LESER supplies flange facings according to ASME B16.5 – 1996, paragraph 6.4.4.3: "Either a serrated concentric or serrated spiral finish resulting in service finish from 125 µinch to 250 µinch average roughness shall be furnished." This finish meets the requirements of MSS SP-6 (Edition 1980), which is not valid anymore!
<b>Stock Finish</b>	Stock finish is not defined in any technical standard. If purchase orders show "stock finish" LESER supplies standard facing according to DIN or ASME (marked with * in table "Flange facings" of each valve series).

## Type 526

### LESER Original Spare Parts Kits

The LESER Spare Parts Kits contain all the parts recommended for the regular maintenance of a LESER safety valve.



#### Content

Item	Component	Material	Quantity
7.5	Securing ring (Disc)	1.4571	1
		316Ti	
14	Split ring	1.4404	2
		316L	
57	Ball	1.4401	15
		316	
59	Securing ring <sup>1)</sup>	1.4571	1
		316Ti	
60	Gasket <sup>2)</sup>	Graphite / 1.4401	3
		Graphite / 316	
61	Ball	1.4401	1
		316	
66	Screw	1.4401	1
		316	
73.2	Gasket (Lock screw)	1.4401	1
		316	

<sup>1)</sup> Kits 5012.1118 and 5012.1119: Kits don't contain securing ring due to re-usable ring bush in the safety valve.

<sup>2)</sup> Kit 5012.1109: Three additional gaskets are enclosed for use in type 5267 (WC6).

#### Article numbers

Orifice	Inlet flange rating class of the safety valve						
	CL150	CL300L	CL300	CL600	CL900	CL1500	CL2500
D	5012.1101				5012.1102		
E	5012.1101				5012.1102		
F	5012.1103						
G	5012.1104					5012.1121	
H	5012.1105		5012.1106				
J	5012.1107		5012.1108				
K	5012.1109				5012.1110		
L	5012.1111		5012.1112				
M	5012.1113						
N	5012.1114						
P	5012.1115		5012.1116				
Q	5012.1117						
R	5012.1118		5012.1119				
T	5012.1120						

## Type 526 Approvals

Orifice		D	E - T
<b>Europe</b>		<b>Coefficient of discharge <math>K_{dr}</math></b>	
PED/DIN EN ISO 4126-1 12/2013	Approval No.	07 202 1111Z0012/2/26	
	S/G	0.45	0.80
	L	0.32	0.58
<b>Germany</b>		<b>Coefficient of discharge <math>\alpha_w</math></b>	
PED/AD 2000-Merkblatt A2 07/2012	Approval No.	TÜV SV 1082	
	S/G	0.45	0.80
	L	0.32	0.58
<b>United States</b>		<b>Coefficient of discharge K</b>	
ASME Sec. VIII Div. 1	Approval No.	M37246	M37224
	S/G	Rated slope acc. to ASME VIII. Div. 1 UG-131 (d) (2) G: 1.99 SCFM/psia S: 5.59 lb/hr/psia	0.801
	Approval No.	M37257	M37235
	L	Rated slope acc. to ASME VIII. Div. 1 UG-131 (d) (2) 3.11 GPM/ $\sqrt{\text{psid}}$	0.579
<b>Canada</b>		<b>Coefficient of discharge K</b>	
Canada: CRN	Approval No.	For current approval no. see <a href="http://www.leser.com">www.leser.com</a>	
	S/G	Rated slope acc. to ASME VIII. Div. 1 UG-131 (d) (2) G: 1.99 SCFM/psia S: 5.59 lb/hr/psia	0.801
	L	Rated slope acc. to ASME VIII. Div. 1 UG-131 (d) (2) 3.11 GPM/ $\sqrt{\text{psid}}$	0.579
<b>China</b>		<b>Coefficient of discharge <math>\alpha_w</math></b>	
AQSIQ	Approval No.	For current approval no. see <a href="http://www.leser.com">www.leser.com</a>	
	S/G	0.45	0.80
	L	0.32	0.58
<b>Eurasian Custom Union</b>		<b>Coefficient of discharge <math>\alpha_w</math></b>	
EAC	Approval No.	For current approval no. see <a href="http://www.leser.com">www.leser.com</a>	
	S/G	0.45	0.80
	L	0.32	0.58
<b>Classification societies</b>		<b>Homepage</b>	
Bureau Veritas	BV	<a href="http://www.bureauveritas.com">www.bureauveritas.com</a>	
Det Norske Veritas	DNV	<a href="http://www.dnv.com">www.dnv.com</a>	
Germanischer Lloyd	GL	<a href="http://www.gl-group.com">www.gl-group.com</a>	
Lloyd's register EMEA	LREMEA	<a href="http://www.lr.org">www.lr.org</a>	
U.S. Coast Guard	U.S.C.G	<a href="http://www.uscg.org">www.uscg.org</a>	
ClassNK NIPPON Kaiji Kyokai (Japan)		<a href="http://www.classnk.or.jp">www.classnk.or.jp</a>	
		The valid certification number is changed with every renewal.	
		For a sample certificate including the valid certification number see <a href="http://www.leser.com">www.leser.com</a>	

# LESER worldwide

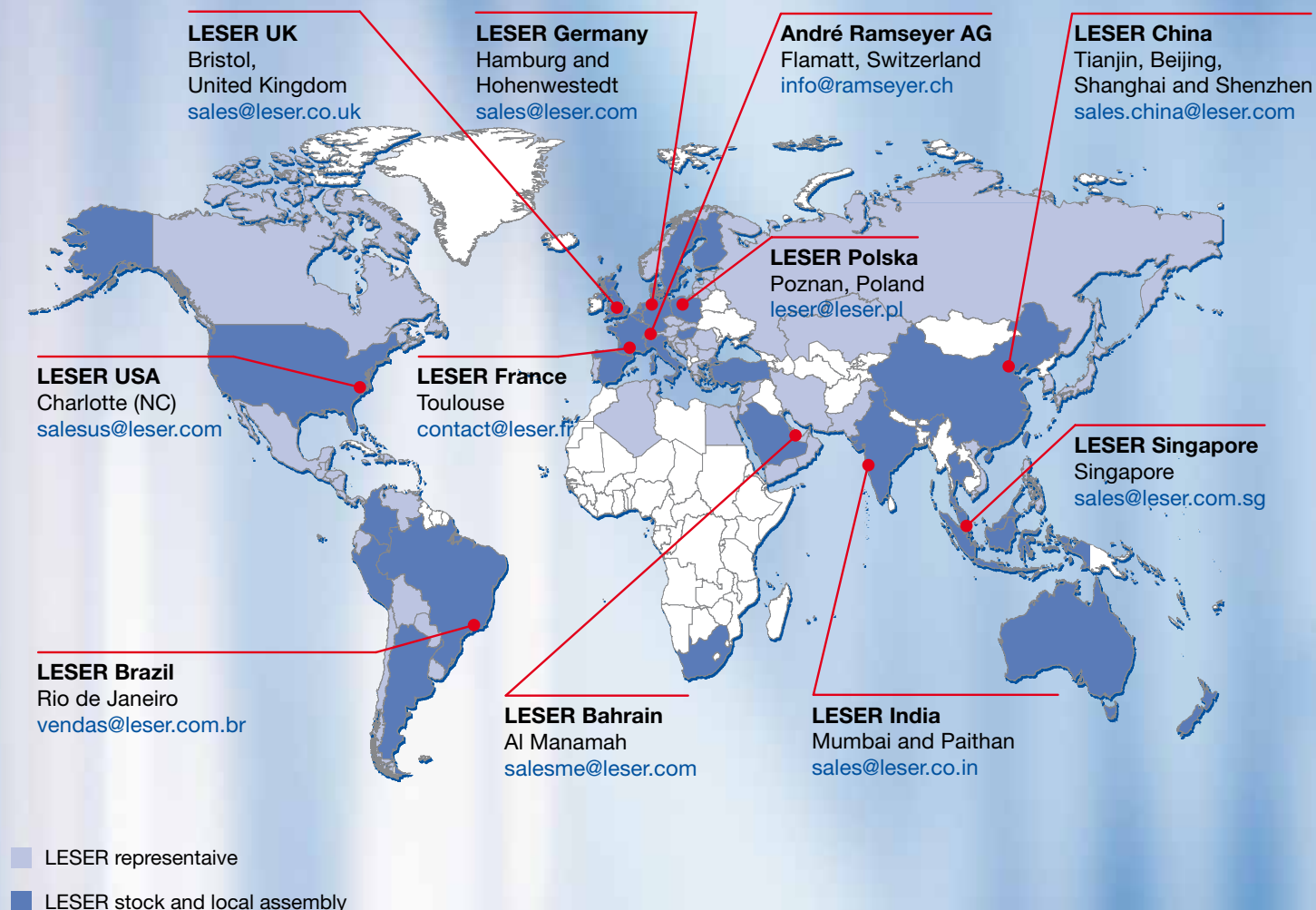

API Catalog  
Edition August 2015  
0777.0055

# LESER

The-Safety-Valve.com

LESER LLC

10615 Texland Boulevard, Suite 100  
Charlotte, NC 28273, USA

Fon +1 704 587-3670  
Fax +1 704 587-3672

E-Mail: [salesus@leser.com](mailto:salesus@leser.com)  
[www.leser.com](http://www.leser.com)