



## ***Recommended BFV Installation, Maintenance & Repair Procedures Ultraflo 300 & 400 Series Valves***

### **I. Introduction**

#### **A. Butterfly Valve Seat / Disc Function**

The seat in most resilient-seated butterfly valves generally has molded O-rings on the flange face. The O-ring provides the necessary valve to flange sealing thus eliminating the need for additional gaskets. Prior to installation, the flange face and molded O-rings of the seat extend beyond the body face-to-face to ensure sealing at the flange. Upon installation, the seat material is compressed and flows toward the center of the valve seat ID. The seat ID of all resilient-seated butterfly valves is smaller than the disc OD providing an interference fit between the disc and seat. This, in addition to the increased interference resulting from the elastomer movement toward the seat center after installation, provides the sealing ability and determines the valves break away/seating torque. Any change in this interference due to improper installation directly affects the pressure rating and seating/unseating torques.

Unlike many valve types, the butterfly valve's disc actually extends beyond the face of the valve body at given angles of opening, approximately 30° or more. Therefore, It is very important before installation to ensure the critical chord dimension of the disc at the full open position is less than the adjacent pipe flange LD.

### **II. Shipment & Storage**

- A. The disc should be positioned so that the disc edge does not extend beyond the face of the valve body
- B. Valves should be stored indoors with care taken to protect the flange sealing surface. Temperature should preferably be 40°F to 85°F.
- C. When valves are stored for extended periods, open and close the valves once every 3 months.
- D. Ship and store valves so that no heavy loads are applied to the bodies.

### **III. Installation Considerations - Piping and Valve Orientation and Placement**

#### **A. Piping and Flange Compatibilities**

Ultraflo resilient seated valves have been designed to fit most types of ANSI 125/150 flanges, including flat-faced, raised face, slip-on (except PTFE lined valves), weld-neck, etc. (Type C stub-end flanges are not recommended for use with resilient-seated butterfly valves.) Each Ultraflo model has been engineered so that the critical disc chord dimension at the full open position will clear the adjacent inside diameter of the piping for which it was designed. The 390/393, 400/422 and 410/412 models have all been designed for Schedule 40 piping and I.D. tubing. The Ultraflo Models 399/392 has been designed for lined & heavy wall piping. If in question, one should compare the minimum pipe I.D. with the published disc chord dimension at full open or contact the factory.

#### **B. Valve Location and Orientation in Piping**

##### **1. Valve Location**

- a. Butterfly valves should be installed if possible a minimum of 6 pipe diameters from other line elements, i.e., elbows, pumps, valves, etc. Of course, 6 pipe diameters are not always practical, but it is important to achieve as much distance as possible.
- b. Where the butterfly valve is connected to a check valve or pump, use an expansion joint between them to ensure the disc does not interfere with the adjacent equipment.

##### **2. Valve Orientation**

- a. In general, Ultraflo recommends the valve be installed with the stem in the vertical position and the actuator mounted vertically directly above the valve; however, there are those applications as discussed below where the stem should be horizontal. Valves should not be installed upside down.

b. For slurries, sludge, mine tailing, pulp stock, dry cement, and any media with sediment or particles, Ultraflo recommends the valve be installed with the stem in the horizontal position with the lower disc edge opening in the downstream direction.

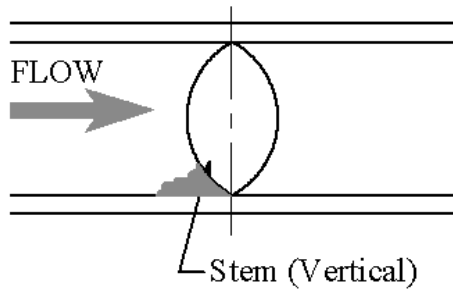

INCORRECT INSTALLATION

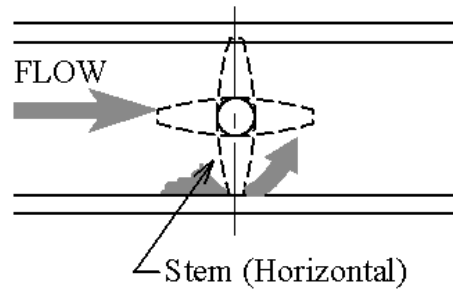

CORRECT INSTALLATION

c. Butterfly valve located at the discharge of a pump should be oriented as follows:

i.) For Centrifugal Pump - Pump shaft horizontal and stem vertical

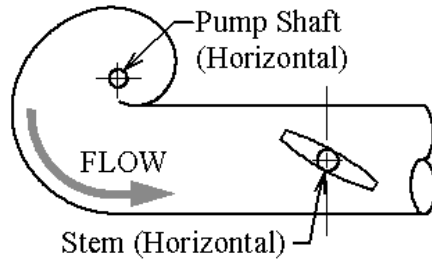

INCORRECT INSTALLATION

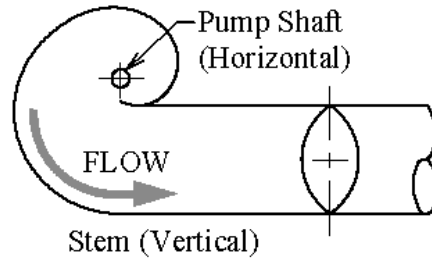

CORRECT INSTALLATION

ii.) Centrifugal Pump - Pump shaft vertical & stem horizontal

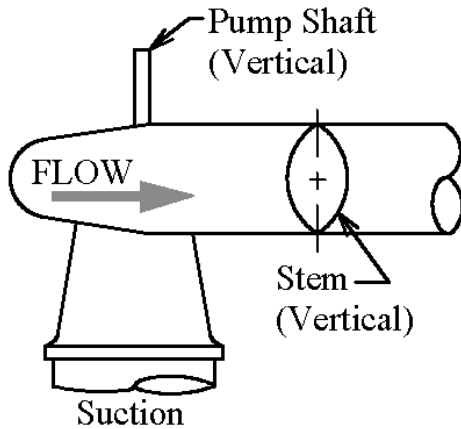

INCORRECT INSTALLATION

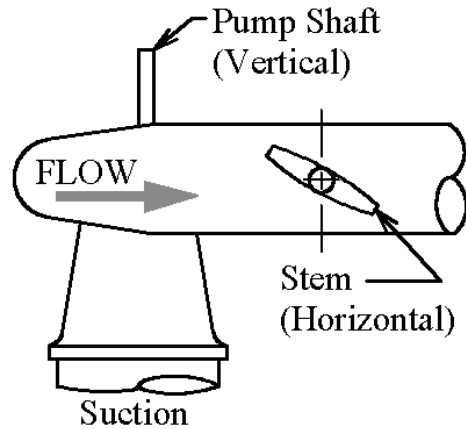

CORRECT INSTALLATION

iii.) Axial Pump - Pump shaft vertical & stem vertical

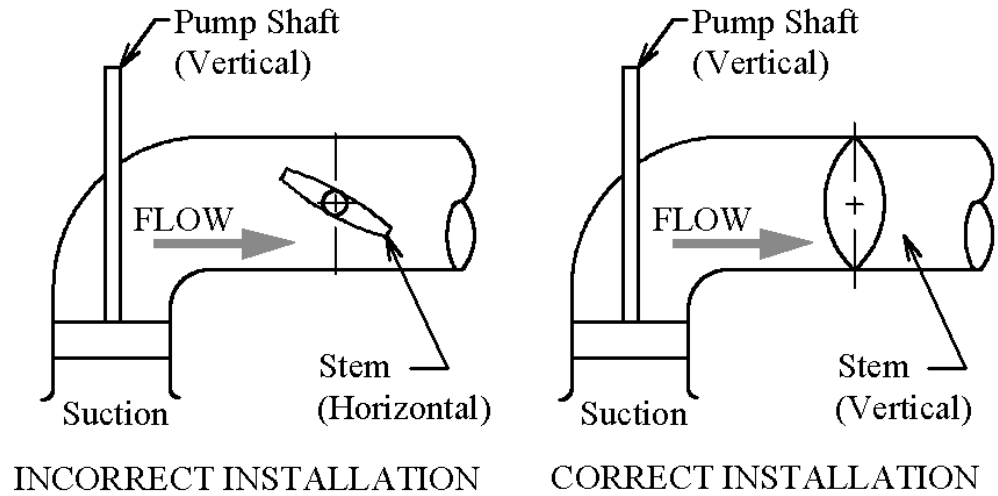

d. Butterfly valves located downstream of a bend or pipe reducer should be oriented as follows:

i.) Bend

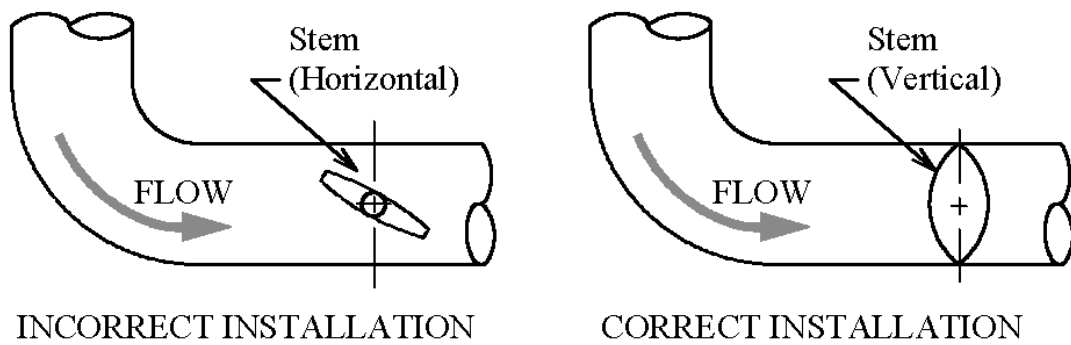

ii.) Tee

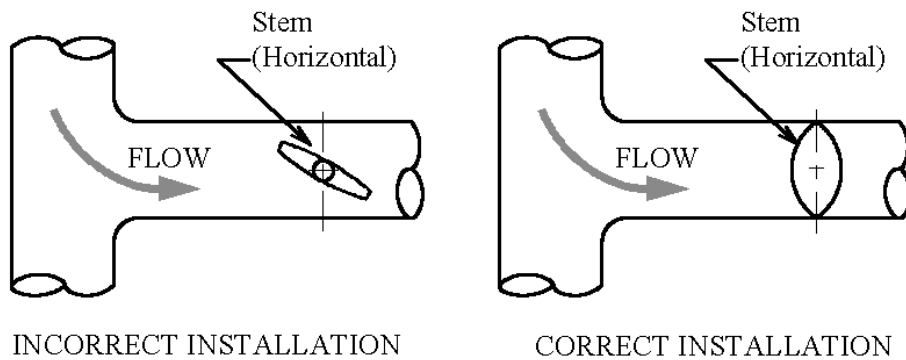

iii.) Pipe Reducer

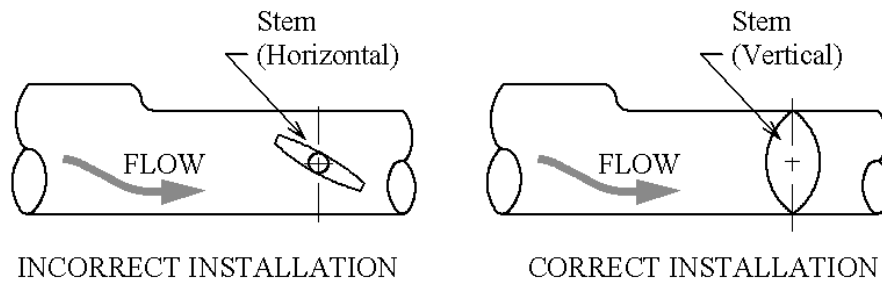

e. Butterfly valves in combination for control/isolation applications should be installed as follows:

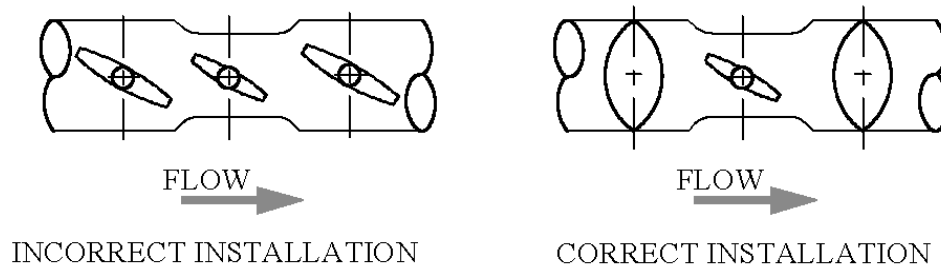

Combination with all valve stems in the same direction accelerates possible noise, vibration, & erosion problems

Combination with the stem of the control valve at right angle to those of other valves tends to cancel the drift of the fluid, and reduces noises, vibration, and erosion

#### IV. Installation Procedures

##### A. General Installation

1. Make sure the pipeline and pipe flange faces are clean. Any foreign material such as pipe scale, metal chips, welding slag, welding rods, etc., can obstruct disc movement or damage the disc or seat.
2. The Ultraflo elastomer seat has molded O-rings on the face of the seat which serve the function of a gasket. As a result, no gaskets are required. The use of flange gaskets can cause excessive compression of the valve seat leading to an increase in torque.
3. Align the piping and then spread the pipe flanges a distance apart so as to permit the valve body to be easily dropped between the flanges without contacting the pipe flanges (*see figure 1 below*)
4. Check to see that the valve disc has been positioned to a partially open position, with the disc edge about 1/4" to 3/8" from the face of the seat, approximately 10° open (*see figure 1 below*).
5. Insert the valve between the flanges as shown below, taking care not to damage the seat faces. Always pick the valve up by the locating holes or by using a nylon sling on the neck of the body. Never pick up the valve by the actuator or operator mounted on top of the valve.

Figure 1 - Insert Butterfly Valve Between Flanges

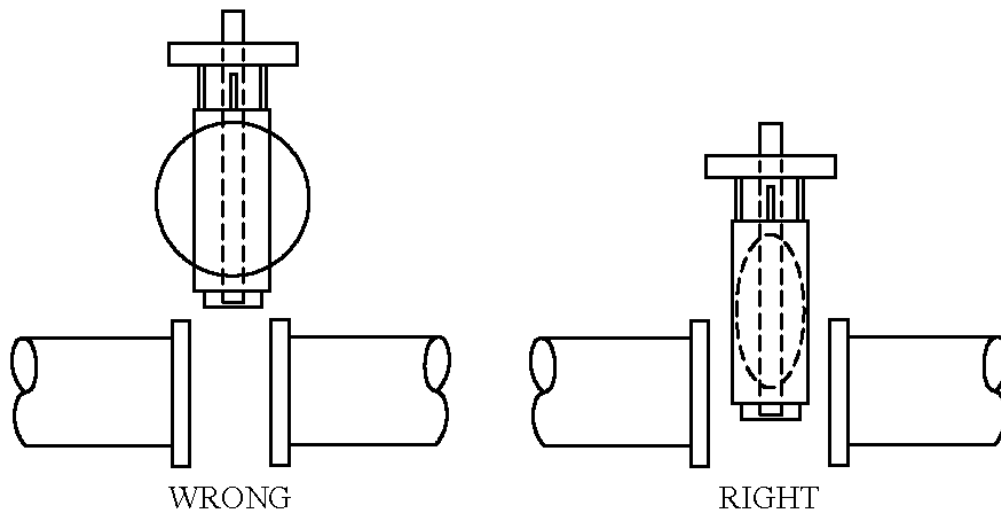

Pipe not spread, disc opened beyond valve body faces. Results: Disc edge damaged when it hits pipe flange.

Pipe spread and aligned, disc rotated such that disc edge is contained within the valve body faces. Results: no undesirable beginning seating/unseating torque, disc edge protected.

- Center the valve between flanges and span the valve body with all flange bolts. Do not tighten the bolts at this time. Slowly operate the valve to the full open position ensuring the disc does not hit the adjacent pipe ID. Now systematically remove jack bolts or other flange spreaders used and hand-tighten the flange bolts as shown in Figure 2. Very slowly close the valve to ensure the disc edge does not come in contact with the adjacent pipe I.D. Now open the disc to full open and tighten all flange bolts per specification as shown in Figure 2. Finally, repeat a full close to full open rotation of the disc to ensure proper clearances (*See figure 3 below*).

Figure 2- Recommended Bolt Tightening Sequence

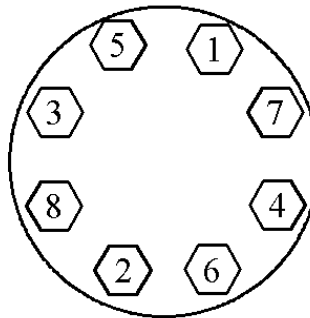

**Figure 3- Final Aligning & Tightening of Flange Bolts**

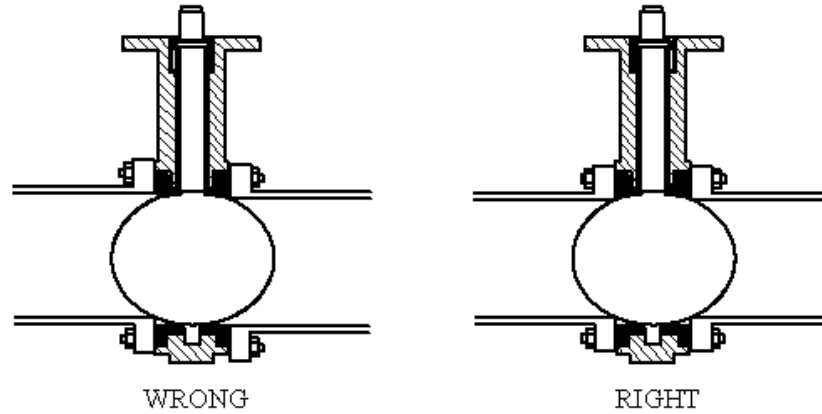

Piping misaligned; Results Disc O.D. strikes pipe I.D. causing disc edge damage, increased torque & leakage. Seat face o-rings seal improperly without engagement.

Piping aligned properly when bolts tightened, disc in full open position; Results - disc clears adjacent pipe I.D., seat face seals properly, no excessive initial torque

### **B. Installation with Flange Welding**

When butterfly valves are to be installed between ANSI welding type flanges, care should be taken to abide by the following procedure to ensure no damage will occur to the seat:

1. Place the valve between the flanges with the flange bores and valve body aligned properly. The disc should be in the 10° open position.
2. Span the body with the bolts.
3. Take this assembly of flange-body-flange and align it properly to the pipe.
4. Tack weld the flanges to the pipe
5. When tack welding is complete, remove the bolts and the valve from the pipe flanges and complete the welding of the flanges. Be sure to let the pipe and flanges cool before installing the valve.

**NOTE:** Never complete the welding process (after tacking) with the valve between pipe flanges. This causes severe seat damage due to heat transfer.

### **V. Maintenance and Repair**

The many Ultraflo features minimize wear and maintenance requirements. No routine lubrication is required. All components - stem, disc, seat, bushing, stem seal, etc., are field replaceable, no adjustment is required. If components require replacement, the valve may be removed from the line by placing the disc in the near closed position, then supporting the valve and removing the flange bolts.

## VI. Disassembly and Assembly

### A. Disassembly

1. **Series 300** - Remove handle, manual gearbox or actuator from actuator mounting flange. Identify means of noting the body halves' orientation with respect to each other for proper re-assembly. Generally, the castings include a matching node on each half, one side only, for alignment purposes. Remove the body bolts and pull the lower body half away from the seat. Pull the seat and disc stem from the upper body half. Remove bushing and seal from the upper body. Push the seat into an oval shape and remove the disc stem by withdrawing the short stem end first. Remove the lower stem bushing. It is sometimes necessary to split the bushing for removal.
2. **Series 400** - Remove the handle, gear operator, or actuator from actuator mounting flange. Remove the disc screws from the face of the disc, then remove the stem. The upper stem bushing and stem seal may be easier to remove after all other components, including the seat are removed so that they can be driven out via access from the valve body ID. Remove the disc from the seat, protecting disc edge at all times. Roll the flange-sealing portion of the seat at one point from the dovetail towards the inner diameter of the valve. Push the seat into an oval shape to collapse the outside diameter of the seat so that the flange seal can be rolled from the dovetail around the periphery and pass through the valve body inner diameter. Then remove the seat from the body. Remove the lower stem bushing. It is sometimes necessary to split the bushing for removal.

### B. Assembly

1. **Series 300 (see following for PTFE lined seats)** - Push the long stem end of the disc stem into one of the seat stem holes taking care not to damage the stem hole sealing surface. Compress the seat into an oval shape so that the short end of the disc stem can be inserted into the opposite stem hole of the seat without force. Place the disc stem and seat into the upper body half. Align the lower body bolt lugs with the upper body lugs and position lower body in the seat. Replace the body bolts and tighten. Install the stem seal, then the stem bushing. Replace handle, manual gearbox or actuator on the actuator-mounting flange. **Note: The body halves generally have a matching casting node on one side only to ensure correct assembly of body halves.**
- 1A. **Series 300 PTFE Lined Seats** – For PTFE lined seats, the following additional procedures are required. Because of the rigidity of the PTFE lining, Ultraflo recommends heating the seats prior to assembly. This eases compression of the seat for disc stem insertion, minimizes potential for damage from scarring the PTFE surface, and assists the PTFE lining in returning to its original shape. The easiest and safest method for heating is to immerse in heated water, near boiling temperature. Inspect all edges coming into contact with the seat for sharp edges or burrs, removing any observed.
2. **Series 400** - Push the valve seat into an oval and push it into the body with seat stem holes aligned to body stem holes. Insert stem seal and bushing. Push stem into the stem hole of body until the bottom of the stem is flush with the inner top edge of the seat. If the service permits, apply a light film of lubricant that is compatible with the elastomer compound onto the I.D. of seat. Insert the disc into the seat by lining up the disc hole with the stem hole of the seat. Note: The disc screw holes in the disc must be toward the top of the valve body. With a downward pressure and rotating the stem back and forth, push the stem until the stem touches the bottom of the body stem hole. Make certain that after pushing stem through disc, the disc screw holes of stem and disc are aligned. Install the disc screws. Note: Torque varies by valve size. Consult factory for torque requirements. Replace the stem packing and bushing.