

# PRATT®

a MUELLER brand

## AWWA BUTTERFLY VALVES 3" - 20"

Engineering Creative Solutions for Fluid Systems Since 1901



**MUELLER**

## TABLE OF CONTENTS

### AWWA BUTTERFLY VALVE 3 - 20"

#### Scope of Line – 3 - 20"

2FII Butterfly Valve .....	1
Monoflange MKII Butterfly Valve .....	1
Design Details.....	2
Features and Benefits.....	3
C <sub>v</sub> Values .....	3
Suggested Specifications.....	4
<b>Dimensions</b>	
2FII (Flanged).....	5
Monoflange MKII (Wafer) .....	5
2MII (Mechanical Joint).....	6
2MFII (Mechanical Joint and Flanged) .....	6
2PII & 2FPII (Push-On and Push-On X Flanged) .....	7
Actuator Dimensional Data .....	8

# SCOPE OF LINE

## AWWA In-Plant Rubber Seated Butterfly Valves

### MODEL 2FII FLANGED BUTTERFLY VALVE

<b>SIZES</b>	3" - 20"
<b>BODY STYLE</b>	Flanged x Flanged Ends
<b>OTHER BODY STYLE OPTIONS</b>	Mechanical Joint Flanged & Mechanical Joint Push-On Push-On & Flanged
<b>PRESSURE CLASS</b>	Class 150B per AWWA Standard C504
<b>WORKING PRESSURE</b>	150 psig
<b>FLANGES</b>	Flat faced and drilled in accordance with ANSI B16.1, Class 125 standards.
<b>RUBBER SEAT</b>	Bonded seat-in-body
<b>ACTUATION OPTIONS</b>	<ul style="list-style-type: none"><li>• Pratt<sup>®</sup> hand lever</li><li>• MDT manual actuator with AWWA nut, handwheel or chainwheel</li><li>• Pratt Dura-Cyl hydraulic or pneumatic cylinder</li></ul>



MODEL 2FII BUTTERFLY VALVE

### MONOFLANGE MKII WAFER BUTTERFLY VALVE

<b>SIZES</b>	3" - 20"
<b>BODY STYLE</b>	Wafer Type
<b>PRESSURE CLASS</b>	Class 150B per AWWA Standard C504
<b>WORKING PRESSURE</b>	150 psig
<b>RUBBER SEAT</b>	Bonded seat-in-body extends over inner surface to form self-gasketing feature
<b>ACTUATION OPTIONS</b>	<ul style="list-style-type: none"><li>• Pratt hand lever</li><li>• MDT manual actuator with AWWA nut, handwheel or chainwheel</li><li>• Pratt Dura-Cyl hydraulic or pneumatic cylinder</li></ul>



MONOFLANGE MKII BUTTERFLY VALVE

# DESIGN DETAILS

## Models 2FII and MKII

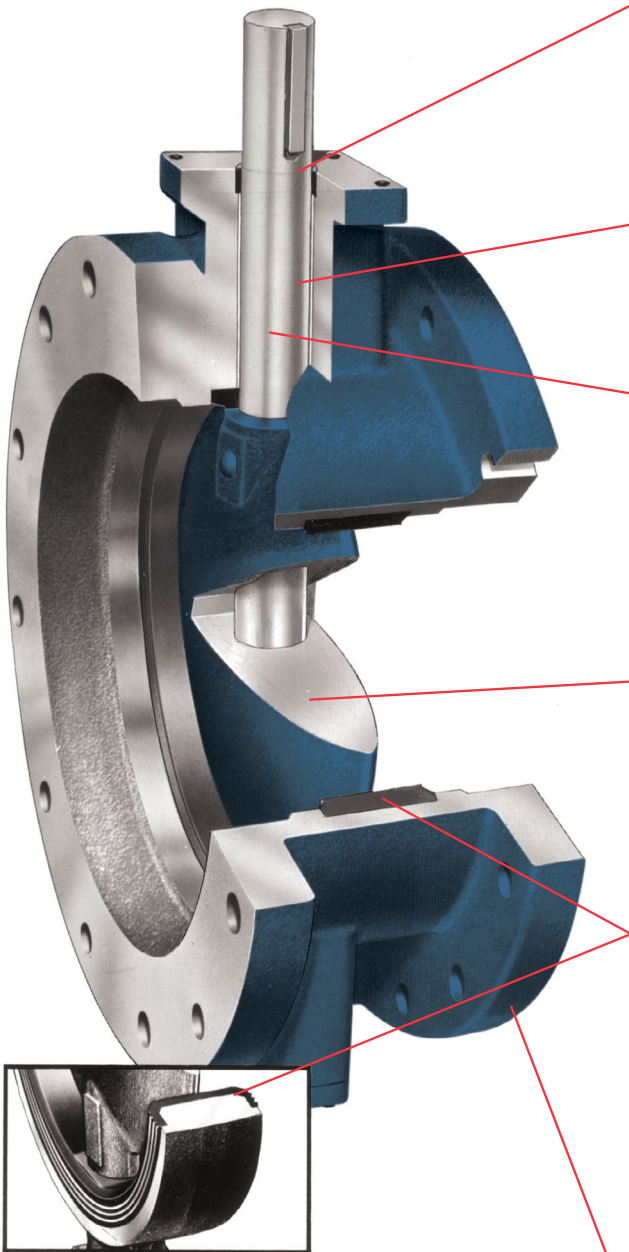

### SELF ADJUSTING PERMANENT PACKING

Chevron type packing increases sealing force as line pressure increases. The self adjusting packing bears on turned, ground and polished stainless steel, minimizing wear and assuring long life. Packing is accessible for replacement without dismantling the valve per AWWA Standard C504.

### LIFETIME BEARINGS

Our chemically inert nylon bearings are sized to meet or exceed AWWA specification pressure loads. They are self-lubricating, require no periodic maintenance and are designed to outlast the life of the pipeline.

### CORROSION RESISTANT SHAFTS

The shafts in the Pratt® rubber seated butterfly valves, 3" through 20", are constructed of centerless, ground ASTM A276 type 304 or type 316 stainless steel bar and thus are not susceptible to corrosion as are carbon steel or other similar materials. Shafts are one-piece, through-shaft construction, sized to meet or exceed the requirements of AWWA Standard C504 for Class 150B butterfly valves.

### STREAMLINED DISCS

Our lens-shaped discs are designed to minimize pressure drop and turbulence. In the full open position, the disc creates no more friction loss than a 45° elbow. Discs are secured to shafts by stainless steel pins to transmit required torques and withstand stresses imposed under a variety of operating conditions.

### BODY SEAT

Our standard seats are constructed of Buna N rubber and bonded to the valve body in the Pratt manufacturing facility using a unique thermal process. This molding process ensures that the disc-to-seat interference will not cause excessive wear or abrasion under normal operating conditions. On the wafer type MKII bodies, the rubber seat covers the entire inner surface plus the outside face of the valve body to provide a self-gasketing feature. The Pratt seat-in-body design minimizes the effects of corrosive buildup on the inside of the valve because deposits are swept away by the hard sealing edge of the disc each time the valve is exercised.

### HEAVY DUTY BODIES

Both Monoflange MKII and Model 2FII bodies are heavy duty cast iron. Model 2FII flanges are fully faced and drilled in accordance with ANSI B16.1, Class 125 standard for cast iron flanges. Monoflange MKII bodies incorporate an overlapping seat which also forms a gasket for the flange face. The actuator mounting trunnion is machined and drilled for a 4-bolt connection.

# FEATURES AND BENEFITS

## Models 2FII and MKII

### FEATURE

- Seat-in-body design. Seat molded in recessed body cavity, protected by metal on 3 sides
- Valve withstood proof-of-design testing of 100,000 cycles — AWWA only requires 10,000 cycle proof-of-design testing
- Through-disc pinning
- Symmetrical lens-shaped disc
- Nonmetallic bearings
- Chevron V-type packing

### BENEFIT

- Reduces seat failure due to corrosive buildup in the valve and pipeline. No hardware to loosen. No periodic maintenance required. Rubber protected from flow media to increase seat life.
- Proven reliability over the life of the valve
- Provides a tight disc-to-shaft pin connection, greatly reducing the possibility of loosening through vibration
- Higher  $C_v$ : lower head loss results in energy savings for customer's system
- Prevents galvanic corrosion and provides lower coefficient of friction
- Self-adjusting, lasts the life of the valve

VALVE SIZE	CV	VALVE SIZE	CV	VALVE SIZE	CV
3"	323	10"	4458	16"	11413
4"	575	12"	6420	18"	14444
6"	1294	14"	8738	20"	17832
8"	2300	Cv values for the 2FII and MKII in the full open position			

VALVE MODEL	BODY	SEAT	DISC	SHAFT
<b>2FII / MKII 3"-6"</b>	ASTM A536 (65-45-12) Ductile Iron	Buna-N**	CF8M or Nickel Al / Bz (6")	Stainless Steel, Type 304
<b>2FII 8" - 20"</b>	ASTM A126, Class B Cast Iron*	Buna-N**	Cast Iron / 316 Edge or Nickel Al/Bz	Stainless Steel, Type 304
<b>MKII 8"-20"</b>	ASTM A536, (65-45-12) Ductile Iron	Buna-N**	Cast Iron / 316 Edge	Stainless Steel, Type 304

\* Model 2FII valves also available with optional ASTM A536 (65-45-12) ductile iron body for all sizes and ductile iron disc on sizes 8"-20"

\*\*Also available with optional EPDM seat

# SUGGESTED SPECIFICATIONS

## Pratt® Rubber Seated Butterfly Valve, Sizes 3" - 20"

### GENERAL

Butterfly valves shall be manufactured in accordance with the latest revision of AWWA C504, Class 150B and conform to ANSI / NSF 61 and ANSI NSF 372. The manufacturer shall have produced AWWA butterfly valves for a minimum of five years. All valves shall be either Pratt Model 2FII or Monoflange MKII and comply with the following details.

### VALVE BODIES

Valve bodies shall be constructed of ASTM A126, Class B cast iron for 8" - 20" flanged valves or ASTM A536 (65-45-12) for wafer style and 3" - 6" flanged valves. Flanged valves shall be fully faced and drilled in accordance with ANSI Standard B16.1, Class 125.

### VALVE SEATS

Rubber body seats shall be of one piece construction, simultaneously molded and bonded into a recessed cavity in the valve body. Seats may not be located on the disc or be retained by segments and/or screws. For wafer style valves, the seat shall cover the entire inner surface of the valve body and extend over the outside face of the valve body to form a flange gasket.

### VALVE BEARINGS

Valve bearings shall be of a self-lubricating, nonmetallic material to effectively isolate the disc-shaft assembly from the valve body. Metal-to-metal thrust bearings in the flow stream are not allowed.

### VALVE DISC

The disc shall be a lens-shaped design to afford minimal pressure drop and line turbulence. Materials of construction shall be:

- 3"-6" — ASTM A351 Gr. CF8M stainless steel disc
- 8"-20" — ASTM A126, Class B cast iron disc with a stainless steel type 316 edge

Discs shall be retained by stainless steel pins which should extend through the full diameter of the shaft to withstand the specified line pressure up to valve rating and the torque required to operate the valve. Disc stops located in the flow stream are not allowed.

### VALVE SHAFTS

Valve shafts shall be of stainless steel type 304. At the operator end of the valve shaft, a packing gland utilizing "V" type chevron packing shall be utilized. "O" ring and/or "U" cup packing is not allowed.

### PAINTING

All surfaces of the valve interior shall be clean, dry and free from grease before painting. The valve interior and exterior, except for disc edge, rubber seat and finished portions shall be evenly coated with an NSF61 approved 2-part liquid epoxy. Minimum dry film thickness shall be 8 Mils.

### TESTING

Hydrostatic and seat leakage tests shall be conducted in strict accordance with AWWA Standard C504.

### PROOF OF DESIGN

The manufacturer furnishing valves under the specification shall be prepared to provide Proof of Design Test reports to illustrate that the valves supplied meet the design requirements of AWWA C504.

**Manual Actuators:** Manual actuators shall be of the traveling nut, self-locking type and shall be designed to hold the valve in any intermediate position between fully open and fully closed without creeping or fluttering. Actuators shall be equipped with mechanical stop-limiting devices to prevent overtravel of the disc in the open and closed positions. Actuators shall be fully enclosed and designed to produce the specified torque with a maximum pull of 80 lb. on the handwheel or chainwheel. Actuator components shall withstand an input torque of 450 Lb. Ft. at extreme operator position without damage. Manual actuators shall conform to AWWA C504 and shall be Pratt MDT or an approved equal.

**Powered Actuators:** Refer to the Pratt Butterfly Valve Actuator brochure for suggested specifications and detailed information regarding cylinder actuators and electric actuators.



# DIMENSIONAL DATA

## Model 2FII, Flanged Butterfly Valve & Monoflange MKII Wafer Butterfly Valve

### MODEL 2FII, FLANGED BUTTERFLY VALVE

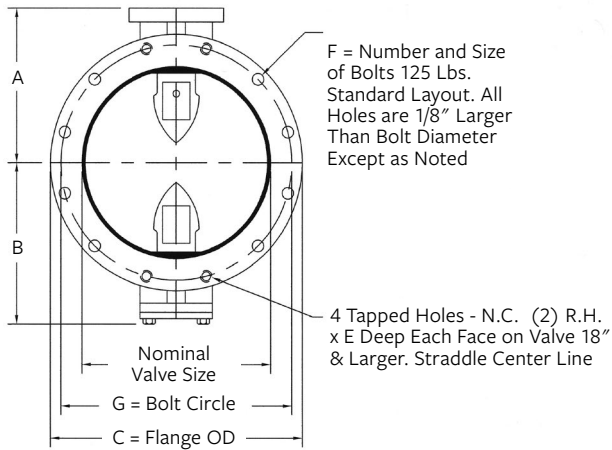

#### NOMINAL VALVE

SIZE	A	B	C	D	E	F	G
3	4 3/4	3 1/4	7 1/2	5	3/4	4 - 5/8	6
4	5 1/2	3 1/2	9	5	15/16	8 - 5/8	7 1/2
6	6 1/2	5 1/8	11	5	1	8 - 3/4	9 1/2
8	7 3/4	6 1/2	13 1/2	6	1 1/8	8 - 3/4	11 3/4
10	9	9 7/8	16	8	1 3/16	12 - 7/8	14 1/4
12	10 1/2	11 3/8	19	8	1 1/4	12 - 7/8	17
14	11 7/8	12 3/4	21	8	1 3/8	12 - 1	18 3/4
16	13 1/2	14 3/8	23 1/2	8	1 7/16	16 - 1	21 1/4
18	14 3/8	15 1/4	25	8	1 9/16	16 - 1 1/8	22 3/4
20	16	16 7/8	27 1/2	8	11 1/16	20 - 1 1/8	25

All dimensions shown in inches.

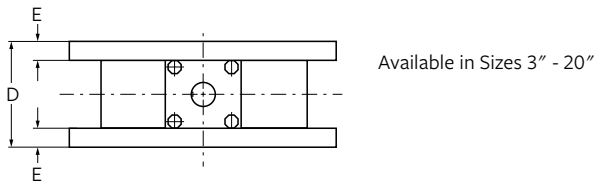

### MONOFLANGE MKII WAFER BUTTERFLY VALVE

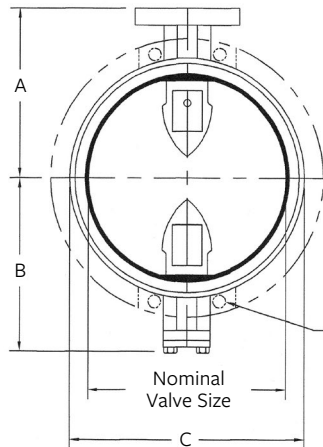
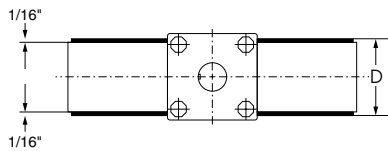

Phantom Lines Show Trunnion Modifications on the Following Valve  
20" - 1 1/8"-7 Tap X 1 1/2" Deep-4 Places Each Face

VALVE SIZE (IN.)	DISC O.D. (IN.)	MINIMUM MATING PIPE I.D. (IN.)*
3	3.089	2.41
4	4.074	3.44
6	6.070	5.38
8	8.078	7.53
10	10.098	9.62
12	12.108	11.64
14	13.339	12.86
16	15.336	14.79
18	17.370	16.75
20	19.380	18.71

#### NOMINAL VALVE

SIZE	A	B	C	D
3	4 3/4	3 1/4	5 1/4	2 1/16
4	5 1/2	3 1/2	6 3/4	2 5/16
6	6 1/2	5 1/8	8 5/8	2 15/16
8	7 3/4	6 1/2	10 7/8	3 1/16
10	9	9 7/8	13 1/4	3 3/16
12	10 1/2	11 5/16	16	3 7/16
14	11 7/8	12 3/4	17 5/8	3 11/16
16	13 1/2	14 3/8	20 1/8	4 3/16
18	14 3/8	15 1/4	21 1/2	4 11/16
20	16	16 13/16	23 3/4	5 3/16

All dimensions shown in inches.

# DIMENSIONAL DATA

## Models 2MII & 2MFII Butterfly Valves

### MODEL 2MII MECHANICAL JOINT END BUTTERFLY VALVE

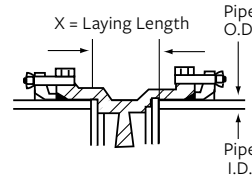
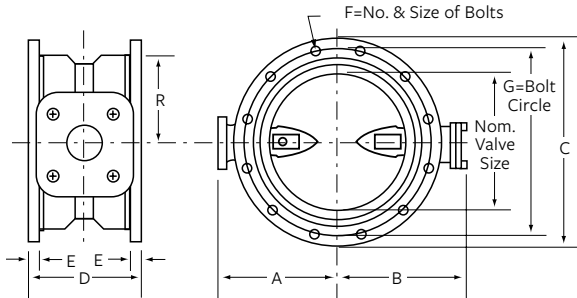

INSTALLATION DIAGRAM

Note: The following items to be furnished by others unless otherwise specified in contract: Bolts, Glands, Nuts, Gaskets

#### NOMINAL VALVE

SIZE	A	B	C	D	E	F	G	X
4	5 1/2	3 1/2	9	8 1/8	1	4 - 3/4	7 1/2	3 1/8
6	6 1/2	5 1/8	11	8 1/2	1 1/16	6 - 3/4	9 1/2	3 1/2
8	7 3/4	6 1/2	13 1/4	8 5/8	1 1/8	6 - 3/4	11 3/4	3 5/8
10	9	9 3/4	15 9/16	9 1/4	1 3/16	8 - 3/4	14	4 1/4
12	10 1/2	11 3/8	17 15/16	9 1/4	1 1/4	8 - 3/4	16 1/4	4 1/4
14	11 7/8	12 3/4	20 5/16	11 1/2	1 5/16	10 - 3/4	18 3/4	4 1/2
16	13 1/2	14 5/16	22 9/16	12	1 3/8	12 - 3/4	21	5
18	14 3/8	15 3/8	24 11/16	12 1/4	1 3/8	12 - 3/4	23 1/4	5 1/4
20	16	17	27 3/32	12 1/2	1 1/2	14 - 3/4	25 1/2	5 1/2

All dimensions shown in inches.

Mechanical joint end is in compliance with ANSI 21.11.

PIPE SIZE	PIPE O.D.	PIPE I.D. MIN.
4	4.80	3.10
6	6.90	5.69
8	9.05	7.65
10	11.10	9.93
12	13.20	11.70
14	15.30	12.91
16	17.40	14.91
18	19.50	16.95
20	21.60	18.96

Available in sizes 4" - 20"  
See Note 1

### MODEL 2MFII MECHANICAL JOINT AND FLANGE END BUTTERFLY VALVE

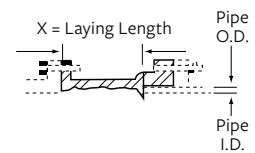
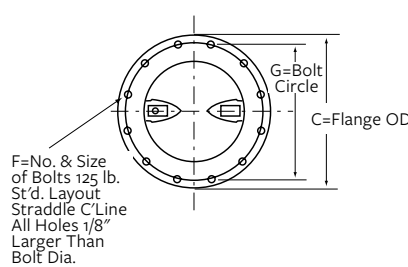
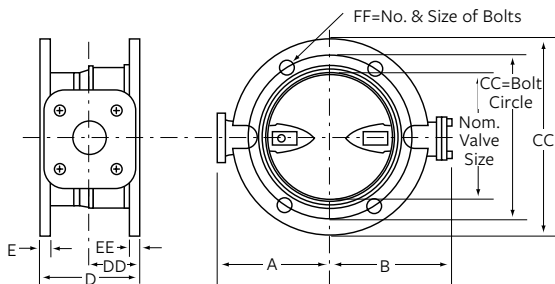

INSTALLATION DIAGRAM

NOTE: Bolts, Nuts, Glands and Gaskets furnished by others unless otherwise specified in contract.

#### NOMINAL VALVE

SIZE	A	B	C	CC	D	DD	E	EE	F	FF	G	GG	X
6	6 1/2	5 1/8	11	11	6 3/4	4 1/4	1 1/16	1 1/16	8 - 3/4	6 - 3/4	9 1/2	9 1/2	4 1/4
8	7 3/4	6 1/2	13 1/2	13 1/4	7 5/16	4 5/16	1 1/8	1 1/8	8 - 3/4	6 - 3/4	11 3/4	11 3/4	4 13/16
10	9	9 7/8	16	15 9/16	8 5/8	4 5/8	1 1/4	1 3/16	12 - 7/8	8 - 3/4	14 1/4	14	6 1/8
12	10 1/2	11 3/8	19	17 15/16	8 5/8	4 5/8	1 1/4	1 1/4	12 - 7/8	8 - 3/4	17	16 1/4	6 1/8
14	11 7/8	12 3/4	21	20 5/16	9 3/4	5 3/4	1 3/8	1 5/16	12 - 1	10 - 3/4	18 3/4	18 3/4	6 1/4
16	13 1/2	14 3/8	23 1/2	22 9/16	10	6	1 7/16	1 3/8	16 - 1	12 - 3/4	21 1/4	21	6 1/2
18	14 3/8	15 1/4	25	24 11/16	10 1/8	6 1/8	1 9/16	1 7/16	16 - 1 1/8	12 - 3/4	22 3/4	23 1/4	6 5/8
20	16	16 7/8	27 1/2	27 3/32	10 1/4	6 1/4	1 11/16	1 1/2	20 - 1 1/8	14 - 3/4	25	25 1/2	6 3/4

All dimensions shown in inches.

PIPE SIZE	PIPE O.D.	PIPE I.D. MIN.
4	4.80	3.10
6	6.90	5.69
8	9.05	7.65
10	11.10	9.93
12	13.20	11.70
14	15.30	12.91
16	17.40	14.91
18	19.50	16.95
20	21.60	18.96

Available in sizes 6" - 20"  
See Note 1

Note 1: Min. Pipe I.D. value has zero clearance between mating pipe and valve disc. Properly sized piping must include appropriate clearance.



# DIMENSIONAL DATA

## Models 2PII & 2FPII Butterfly Valves

### MODEL 2PII PUSH-ON JOINT END BUTTERFLY VALVE

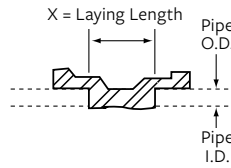
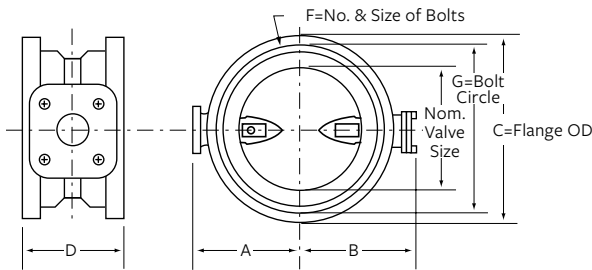

**INSTALLATION DIAGRAM**  
 Note: Rubber ring gaskets furnished by others unless otherwise specified in contract.

#### NOMINAL VALVE

SIZE	A	B	C	D	X
4	5 1/2	3 1/2	6 7/8	10 3/8	3 1/8
6	6 1/2	5 1/8	9	10 3/4	3 1/2
8	7 3/4	6 1/2	11 1/4	12	3 5/8
10	9	9 7/8	14	12 5/8	4 1/8
12	10 1/2	11 3/8	16 3/8	15	5 1/8
14	11 7/8	12 3/4	18 7/8	14 3/4	4 1/2
16	13 1/2	14 3/8	21 1/4	15	4 3/4

PIPE SIZE	PIPE O.D.	PIPE I.D. MIN.
4	4.80	2.61
6	6.90	4.96
8	9.05	7.22
10	11.10	9.22
12	13.20	10.97
14	15.30	12.56
16	17.40	14.59

- All dimensions shown in inches.
- Available in sizes 4 through 16 inches.
- D ± 1/16" through 10" valves, ± 1/8" for 12" and larger valves.
- The valve end is designed for iron or PVC pipe with cast iron equivalent O.D.s (not for use with IPS O.D. pipe).
- Use with "Tyton" (Reg. T.M. or U.S. Pipe & Foundry Co.) rubber ring gasket.

See Note 1.

### MODEL 2FPII PUSH-ON X FLANGE END BUTTERFLY VALVE

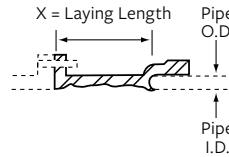
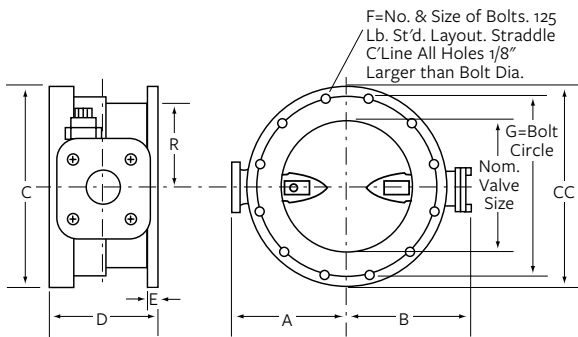

**INSTALLATION DIAGRAM**  
 Note: Bolts, Nuts, and Rubber Gaskets furnished by others unless otherwise specified in contract.

#### NOMINAL VALVE

SIZE	A	B	C	CC	D	E	F	G
4	5 1/2	3 1/2	6 7/8	9	7 11/16	1 5/16	8 - 5/8	7 1/2
6	6 1/2	5 1/8	9	11	7 7/8	1	8 - 3/4	9 1/2
8	7 3/4	6 1/2	11 1/4	13 1/2	8 15/16	1 1/8	8 - 3/4	11 3/4
10	9	9 7/8	14	16	10 15/16	1 3/16	12 - 7/8	14 1/2
12	10 1/2	11 3/8	16 3/8	19	11 1/2	1 1/4	12 - 7/8	17
14	11 7/8	12 11/16	18 7/8	21	11 3/8	1 3/8	12 - 1	18 3/4
16	13 1/2	14 5/16	21 1/4	23 1/2	11 1/2	1 7/16	16 - 1	21 1/4

PIPE SIZE	PIPE O.D.	PIPE I.D. MIN.
4	4.80	2.61
6	6.90	4.96
8	9.05	7.22
10	11.10	9.22
12	13.20	10.97
14	15.30	12.56
16	17.40	14.59

- All dimensions shown in inches.
- Available in sizes 4 through 16 inches.
- D ± 1/16" through 10" valves, ± 1/8" for 12" and larger valves.
- The valve end is designed for iron or PVC pipe with cast iron equivalent O.D.s (not for use with IPS O.D. pipe).
- Use with "Tyton" (Reg. T.M. or U.S. Pipe & Foundry Co.) rubber ring gasket.

See Note 1.

**Note 1:** Min. Pipe I.D. value has zero clearance between mating pipe and valve disc. Properly sized piping must include appropriate clearance.

# ACTUATOR DIMENSIONAL DATA

## Models 2FII and MKII Pratt® MDT Manual Actuator

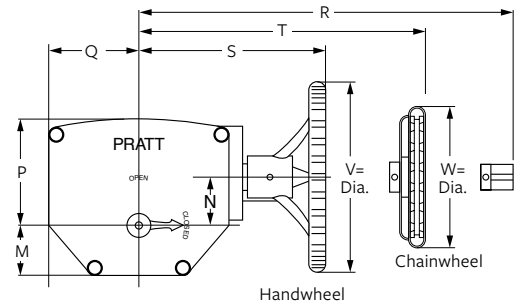
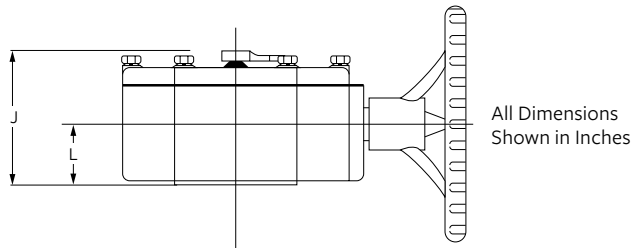

VALVE SIZE	MDT SIZE	J	L	M	N	P	Q	R	S	T	V	W	# TURNS TO CLOSE
<b>3 to 10"</b>	MDT-2S	4 7/8	2	2 1/8	2	4 1/2	4 1/4	7 5/8	7 7/8	7 7/8	8	9 1/8	32
<b>12"</b>	MDT-2S	4 7/8	2	2 1/8	2	4 1/2	4 1/4	7 5/8	7 7/8	7 7/8	12	9 1/8	32
<b>14, 16"</b>	MDT-3S	5 5/8	2 7/16	3 1/4	3 5/32	5 5/8	5 3/8	9 1/4	10 1/2	10	12	9 1/8	30
<b>18, 20"</b>	MDT-4S	6 3/8	2 13/16	3 3/8	4	7 5/16	6 3/4	10 1/2	11 1/2	11	12	9 1/8	40

For further information regarding manual actuators, refer to our Butterfly Valve Actuator brochure.

# NOTES

## PRATT® Product Guide

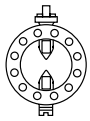

**MODEL 2FII**



**MONOFLANGE MKII**

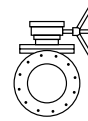

**PLUG VALVES**

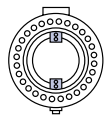

**TRITON® XR70**

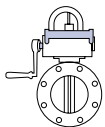

**INDICATING BUTTERFLY  
VALVES UL & FM APPROVED**

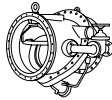

**TILTING DISC  
CHECK VALVES**

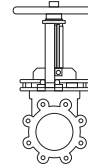

**KNIFE GATE VALVES**

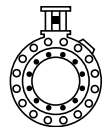

**N-STAMP NUCLEAR  
BUTTERFLY VALVES**

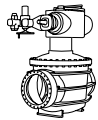

**CONE VALVES**

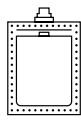

**RECTANGULAR**

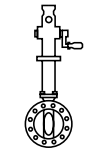

**PIVA POST INDICATING VALVES  
ASSEMBLY UL & FM APPROVED**

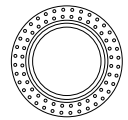

**SLEEVE VALVES**

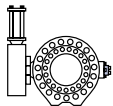

**RUBBER SEATED  
BALL VALVES**

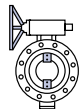

**TRITON® 250**

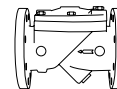

**CHECK VALVES**

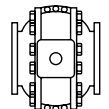

**METAL SEATED  
BALL VALVE**



**CONTROL SYSTEMS**

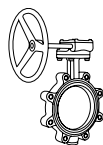

**INDUSTRIAL VALVES**

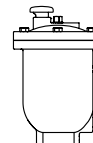

**AIR VALVES**

**For more information about us or to view our full line of water products, please visit [www.prattvalve.com](http://www.prattvalve.com) or call Pratt customer service at 1.800.423.1323.**

Mueller refers to one or more of Mueller Water Products, Inc., a Delaware corporation ("MWP"), and its subsidiaries. MWP and each of subsidiaries are legally separate and independent entities when providing products and services. MWP does not provide products or services to third parties. MWP and each of its subsidiaries are liable only for their own acts and omissions and not those of each other. MWP brands include Mueller®, Echologics®, Hydro Gate®, Hydro-Guard®, Jones®, Mi.Net®, Milliken®, Pratt®, Singer®, and U.S. Pipe Valve & Hydrant. Please see [www.muellerwp.com/about](http://www.muellerwp.com/about) to learn more.

Copyright © 2018 Henry Pratt Company, LLC. All Rights Reserved. The trademarks, logos and service marks displayed in this document are the property of Mueller Water Products, Inc., its affiliates or other third parties. Products marked with a section symbol (S) are subject to patents or patent applications. For details, visit [www.mwppat.com](http://www.mwppat.com). These products are intended for use in potable water applications. Please contact your Mueller Sales or Customer Service Representative concerning any other application(S).