

Eclipse™ by StoneL

Valve monitor series EG

Installation, maintenance and
operating instructions



Eclipse (EG) Model Number Descriptions (Example: EG33C26RA)

EG	Function	Enclosure/Approvals	Entry Options	Visual Indicator	Brand	Options
33	Sensor Modules (2) SST N.O. Sensors	C North American (NEC/CEC)	23 (1) 4-pin M12 Male Connector	R Red Closed/Green Open	A Stonel	***** Special
34	(2) SST N.C. Sensors	D International (IEC/ATEX)	24 (1) 4-pin M12 Male Connector (1) 4-pin M12 Female Connector	G Green Closed/Red Open	M Neles	
44	(2) NAMUR Sensors (DIN 19234)	P North American (NEC/CEC)	25 (1) 5-pin M12 Male Connector	F Flow Line		
Bus Communication Modules		A International (IEC/ATEX)	26 (1) 5-pin M12 Male Connector (1) 4-pin M12 Female Connector	1 T1 Three Way (90° rotation) 2 T2 Three Way (90° rotation)		
92	DeviceNet Communication VCT Module		XX Special Configuration	D Red Closed/Green Open		
93	Foundation Fieldbus VCT Module (Bus Powered Outputs)			N Green Closed/Red Open		
94	Foundation Fieldbus VCT Module (24VDC Externally Powered Outputs)			L Flow Line		
95	Modbus Communication VCT Module			S T1 Three Way (90° rotation)		
96	AS-i Communication VCT Module (Standard Addressing Version)			T T2 Three Way (90° rotation)		
97	AS-i Communication VCT Module (Extended Addressing Version)			X Special		

General Specifications and Ratings

Pub # 105149revE

Operating Life	Unlimited	Temperature Range	-40° C to 80° C (-40° F to 180° F)
Materials of Construction (User to check the chemical compatibility of the materials used in their process to ensure chemical compatibility)		Enclosure Protection	NEMA 4, 4X & 6; IP67
Housing	Lexan® Polycarbonate	Warranty	
Drum	Lexan® Polycarbonate	Function Module	Five Years
Fasteners	Stainless Steel	Indicator & Triggering	Two Years
Triggers & Couplings	Stainless Steel	Product Patents	5,623,963; 5,647,396

Lexan is a registered trademark of General Electric Corporation.

Dimensions - Inches (mm)

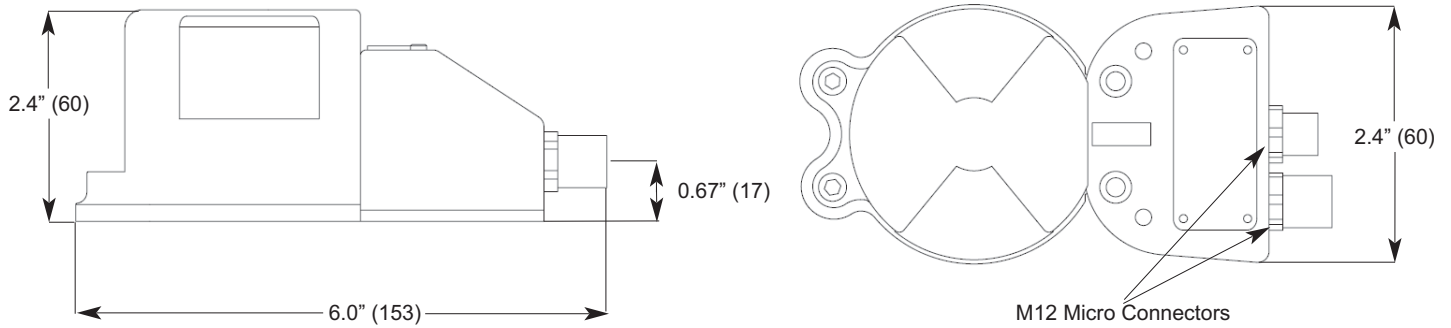

Mounting to ISO-NAMUR Style Actuators

1. (Namur Size 1 & 2)

Attach Function Module using fasteners provided in the mounting kit and tighten to **25-30 inch pounds. (Do not over tighten).**

(Namur Size 3 and Non-Namur applications)

Attach spacer or bracket to actuator with fasteners provided in the mounting kit and tighten securely. Attach Function Module to spacer or bracket and tighten to **25-30 inch pounds. (Do not over tighten).**

- Place the Drive Block into the slot of the actuator shaft. Next, place the Inner Drum over the Drive Block, ensuring the Drive Block goes into the mating recess of the Inner Drum. Now slide both Trigger Adjustment Rings over the Inner Drum (for the Flow Line option, place the yellow flow line bar on top of the Visual Indicator Trigger Assembly). Finally, insert the Drum Fastener (provided with the mounting kit) through the entire Visual Indicator/Trigger Assembly and tighten only a couple of turns into the actuator shaft as to allow the Trigger Adjustment Rings to rotate freely to perform the sensor settings. Ensure the assembly is centered.

Sensor Settings

- Start with the actuator in the closed position. Ensure the Drum Fastener is loose enough to allow the Trigger Adjustment Rings to rotate. Lift and rotate the lower ring until the stainless steel trigger is in front of the lower bulls-eye on the Function Module (lower trigger activates the Red LED). Rotate the actuator to the open position. Lift and rotate the upper ring until the stainless steel trigger is in front of the upper bulls-eye on the Function Module (upper trigger activates Green LED) . For the Flow Line option, lift and rotate the yellow flow line bar on top of the Visual Indicator/Trigger Assembly to indicate desired flow. Securely tighten the Drum Fastener. To adjust simply loosen screw and adjust triggers and indicator to suit your application. LEDs will energize and de-energize when powered, indicating sensor status.

Indicator Cover

- Install the Visual Indicator Cover. The Cover Alignment Ribs on the Visual Indicator Cover are tapered and cannot be inserted vertically into the mating grooves on the Function Module. Place the Visual Indicator Cover over and as close to the Visual Indicator/Trigger Assembly as possible. When the bottom of the Visual Indicator Cover is flush with the base of the Function Module, slide the Visual Indicator horizontally until the Cover Alignment Ribs fit completely into the mating grooves on the Function Module. Tighten the Visual Indicator Cover securely to the actuator with fasteners provided in the mounting kit. **(25-30 inch pounds. Do not over tighten).**

Wiring

- Control and solenoid wires as connected to the Eclipse Function Module via M12 micro-connectors as per information located on pages 5 thru 8.

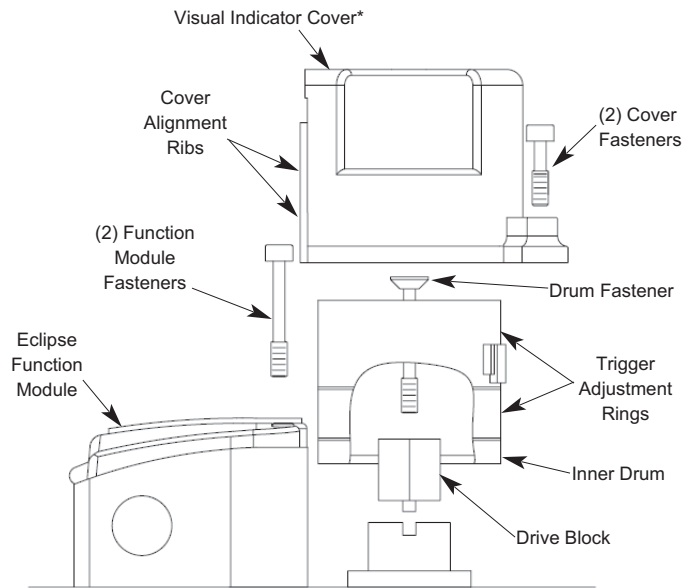

* Standard Flow Line Visual Indicator not provided with cover

Visual Indicator/Trigger Assembly

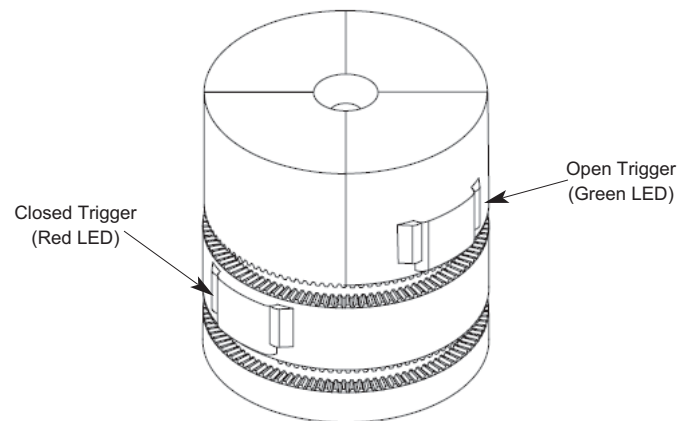

Flow Line Indicator/Trigger Assembly

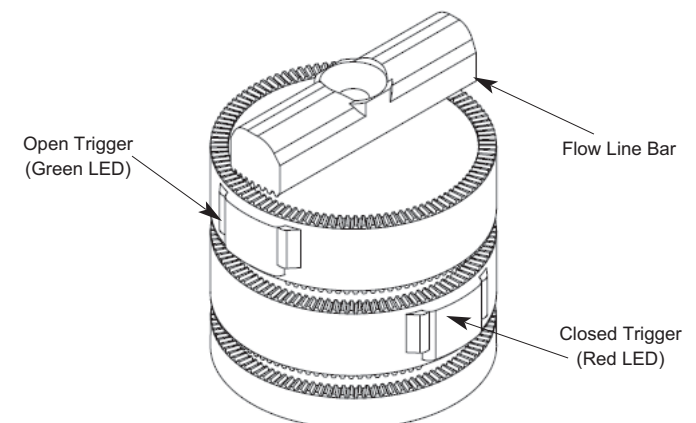

**2 SST™ Solid-State Sensors
(EG33 & EG34)**

Configuration:	(2) Solid State Sensors (Normally Open or Normally Closed)
Indications:	
EG33	Target On Sensor = LED On Target Off Sensor = LED Off
EG34	Target On Sensor = LED Off Target Off Sensor = LED On
Operating Voltage:	8-125 VDC; 24-125 VAC
Maximum Voltage Drop:	6.5 Volts @ 10mA 7.0 Volts @ 100mA
Current Ratings:	
Max Inrush	2.0 Amps @ 125 VDC/VAC
Max Continuous	0.1Amps @ 125 VDC/VAC
Minimum On Current	2.0m A
Leakage Current	<0.15mA with DC Voltage <0.25mA with AC Voltage
To Bench Test a Solid State Sensor Unit: Use StoneL Light Read Tester. Or you may use a 24 VDC or 120 VAC power supply with a series load resistor (2K ohm to 6K ohm). Connect to NO and C (EG33) or NC and C (EG34) male pins.	
WARNING: FAILURE TO USE A SERIES LOAD RESISTOR WHEN BENCH TESTING WITH A POWER SUPPLY WILL RESULT IN PERMANENT DAMAGE TO THE UNIT.	

**2 SST™ Namur Sensors
(EG44)**

Configuration:	(2) Namur Sensors (Normally Closed)
Indications:	Target On Sensor = LED Off Target Off Sensor = LED On
Operating Voltage:	6-29 VDC
Current Ratings:	Target On (LED Off) <1.0mA Target Off (LED On) >3.0mA
Must use intrinsically safe repeater barrier. Namur Sensors conform to EN 60947-5-6 Standard	
See Page 9 or Page 10 for Intrinsic Safety Hazardous Location Installation Diagram	
To Bench Test a Namur Sensor Unit: Use StoneL Light Read Tester or a 6-29 VDC power supply across + and - male pins. No series resistor needed.	

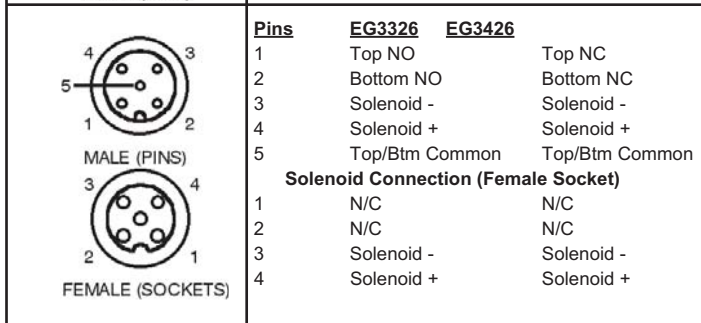
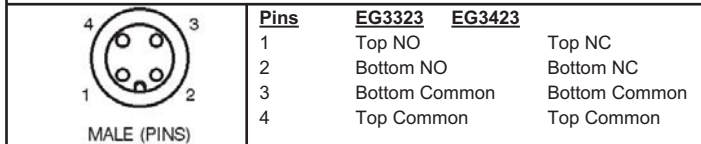
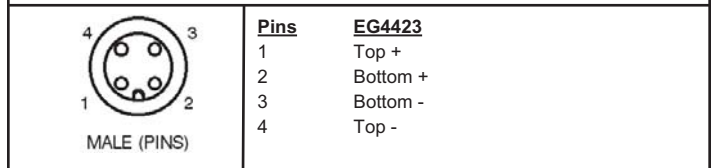

**DeviceNet EG Module
(EG92)**

**Foundation Fieldbus EG Module
(EG93)**

Communication Protocol: DeviceNet
 I/O: (2) Discrete Inputs (Sensors)
 (1) Discrete Output (Solenoid)
 Default Address: 63
 Bit Assignment: Inputs: (3 Bytes)
 Bit 0 = Input 1 (Red LED; Bottom Sensor)
 Bit 1 = Input 2 (Green LED; Top Sensor)
 Bit 4 = Fault Bit (Set when both Input 1 and Input 2 = 1)
 Bits 8-23 = Not Used
 Outputs: (1 Byte)
 Bit 0 = Not Used
 Bit 1 = Output 2 (Solenoid)
 I/O Messaging: Polling, Cyclic, Change of State
 Operating Voltage: 24 VDC via DeviceNet network
 Baud Rates: 125K, 250K, 500K
 Output Voltage: 24 VDC
 Max. Output Current: 160mA
 Max. Output Power: 4 Watts

To Bench Test a DeviceNet Unit: Use 24 VDC power supply across V + (Pin 2) and V - (Pin 3) of male connector. No series resistor needed. To test communication, a functioning DeviceNet network is required.

Communication Protocol: Foundation Fieldbus
 I/O: (2) Discrete Inputs (Sensors)
 (1) Discrete Output (Piezo Valve)
 Function Blocks: 2 DI, 2 DO
 Channel Reference: Channel 1 = DI1 (Green LED)
 Channel 2 = DI2 (Red LED)
 Channel 3 = DO1 (OUT 1)
 Operating Voltage: 9-32 VDC (Foundation Fieldbus Voltage)
 Max Output Current: 2mA @ 6.5 VDC. Current limited to 2mA (Bus Powered). Suitable for StoneL Piezo Valve
 Indication: Red LED = Bottom Sensor
 Green LED = Top Sensor

See Page 11 and Page 12 for Intrinsic Safety (FISCO) Hazardous Location information and Installation Diagram.
See Page 13 for Non-Incendive Field Wiring Apparatus Installation Drawing

To Bench Test a Foundation Fieldbus Module: Use 24 VDC power supply across FB - (Pin 1) and FB + (Pin 2) of male connector. No series resistor needed. To test communication, a functioning Foundation Fieldbus network is required.

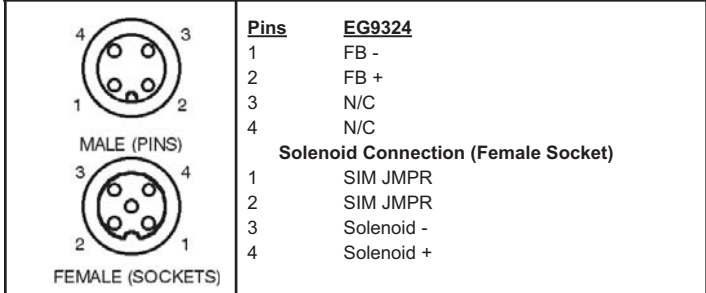
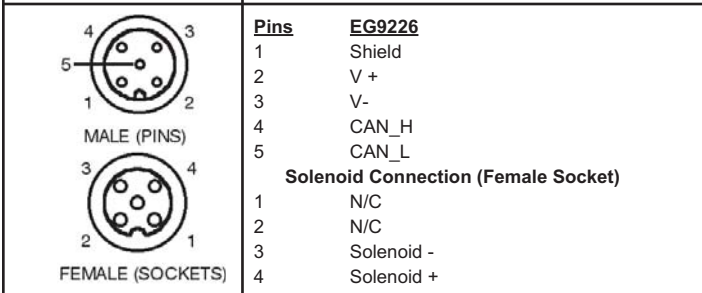
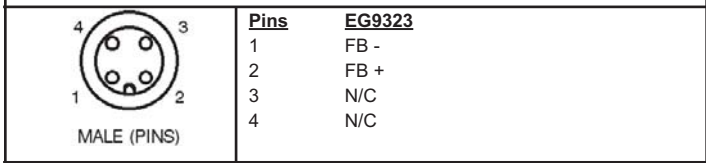
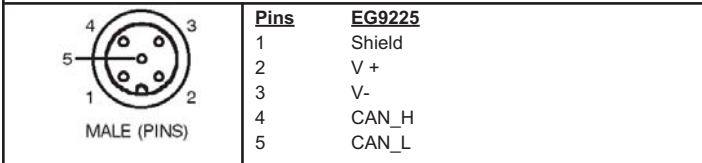

**Modbus EG Module
(EG95)**

**AS-Interface® EG Module
(EG96)**

Communication Protocol: Modbus
 I/O: (2) Discrete Inputs (Sensors)
 (1) Discrete Output (Solenoid)
 Default Address: 03
 Bit Assignment: Inputs:
 10001= Input 1 (Red LED; Bottom Sensor)
 10002 = Input 2 (Green LED; Top Sensor)
 Outputs:
 00001 = Not Used
 00002 = Output 2 (Solenoid 2)
 Operating Voltage: 24VDC (The 24VDC power source should share the same ground reference as the communication line)
 Baud Rates: 9.6K, 19.2K, 38.4K
 Output Voltage: 24VDC
 Max. Output Current: 160mA
 Max. Output Power: 4 Watts

Communication Protocol: AS- Interface (AS-i)
 Configuration: (2) Discrete Inputs (Sensors)
 (1) Discrete Output (Solenoid)
 Default Address: 00
 AS-Interface ID/IO Codes: ID = F; IO = 4; ID1 = F; ID2 = E
 Bit Assignment: Inputs:
 Bit 1 = Not Used
 Bit 2 = Not Used
 Bit 3 = (Green LED; Top Sensor)
 Bit 4 = (Red LED; Bottom Sensor)
 Outputs:
 Bit 1 = Not Used
 Bit 2 = Not Used
 Bit 3 = Output (Solenoid)
 Bit 4 = Not Used
 Operating Voltage: 24-30 VDC (AS-i Voltage)
 Output Voltage: 24 VDC
 Max. Output Current: 160mA
 Max. Output Power: 4 Watts

See Page 14 for Non-Incendive Field Wiring Apparatus Installation Drawing

To Bench Test a Modbus Unit: Use 24 VDC power supply across V + (Pin 2) and V - (Pin 3) of male connector. No series resistor needed. To test communication, a functioning DeviceNet network is required.

To Bench Test AS-i Module: Use 24 VDC power supply across AS-I + (Pin 1) and AS-I - (Pin 3) of male connector. No series resistor needed. To test communication, a functioning AS-i network is required.

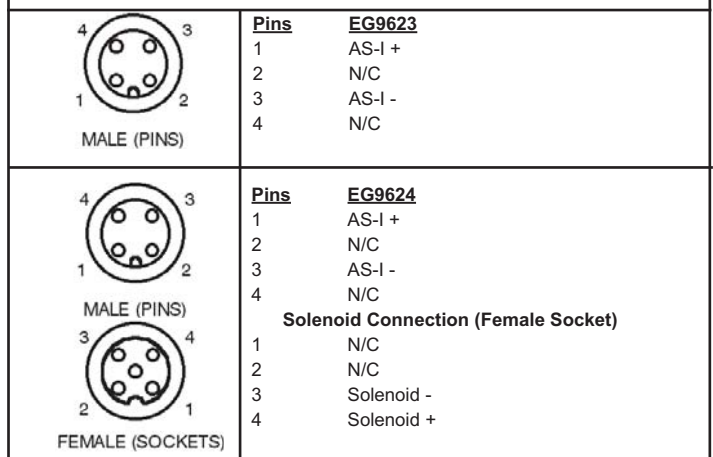
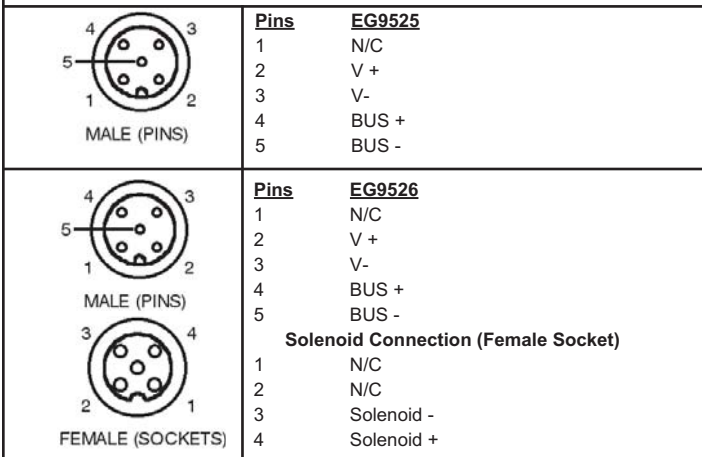

**AS-Interface® EG Module
(EG97)**

Communication Protocol: AS- Interface (AS-i)
 Configuration: (2) Discrete Inputs (Sensors)
 (1) Discrete Output (Solenoid)
 Default Address: 0A
 AS-Interface ID/IO Codes: ID = A; IO = 4; ID1 = 7; ID2 = E
 Bit Assignment: Inputs:
 Bit 1 = Not Used
 Bit 2 = Not Used
 Bit 3 = (Green LED; Top Sensor)
 Bit 4 = (Red LED; Bottom Sensor)
 Outputs:
 Bit 1 = Not Used
 Bit 2 = Not Used
 Bit 3 = Output (Solenoid)
 Bit 4 = Not Used
 Operating Voltage: 24-30 VDC (AS-i Voltage)
 Output Voltage: 24 VDC
 Max. Output Current: 100mA
 Max. Output Power: 2.4 Watts

**See Page 14 for Non-Incendive Field Wiring Apparatus
Installation Drawing**

To Bench Test AS-i Module: Use 24 VDC power supply across AS-I + (Pin 1) and AS-I - (Pin 3) of male connector. No series resistor needed. To test communication, a functioning AS-i network is required.

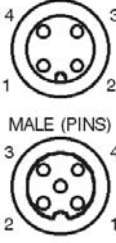
 <p>MALE (PINS)</p>	<p>Pins EG9723</p> <p>1 AS-I + 2 N/C 3 AS-I - 4 N/C</p>
 <p>MALE (PINS)</p> <p>FEMALE (SOCKETS)</p>	<p>Pins EG9724</p> <p>1 AS-I + 2 N/C 3 AS-I - 4 N/C</p> <p>Solenoid Connection (Female Socket)</p> <p>1 N/C 2 N/C 3 Solenoid - 4 Solenoid +</p>

EG44D or A___ models approved for Intrinsically Safe Installations: (Ex ia IIC T5)

EG4423D or A___*

*Note: Any Visual Indicator/Trigger Assembly option is approved

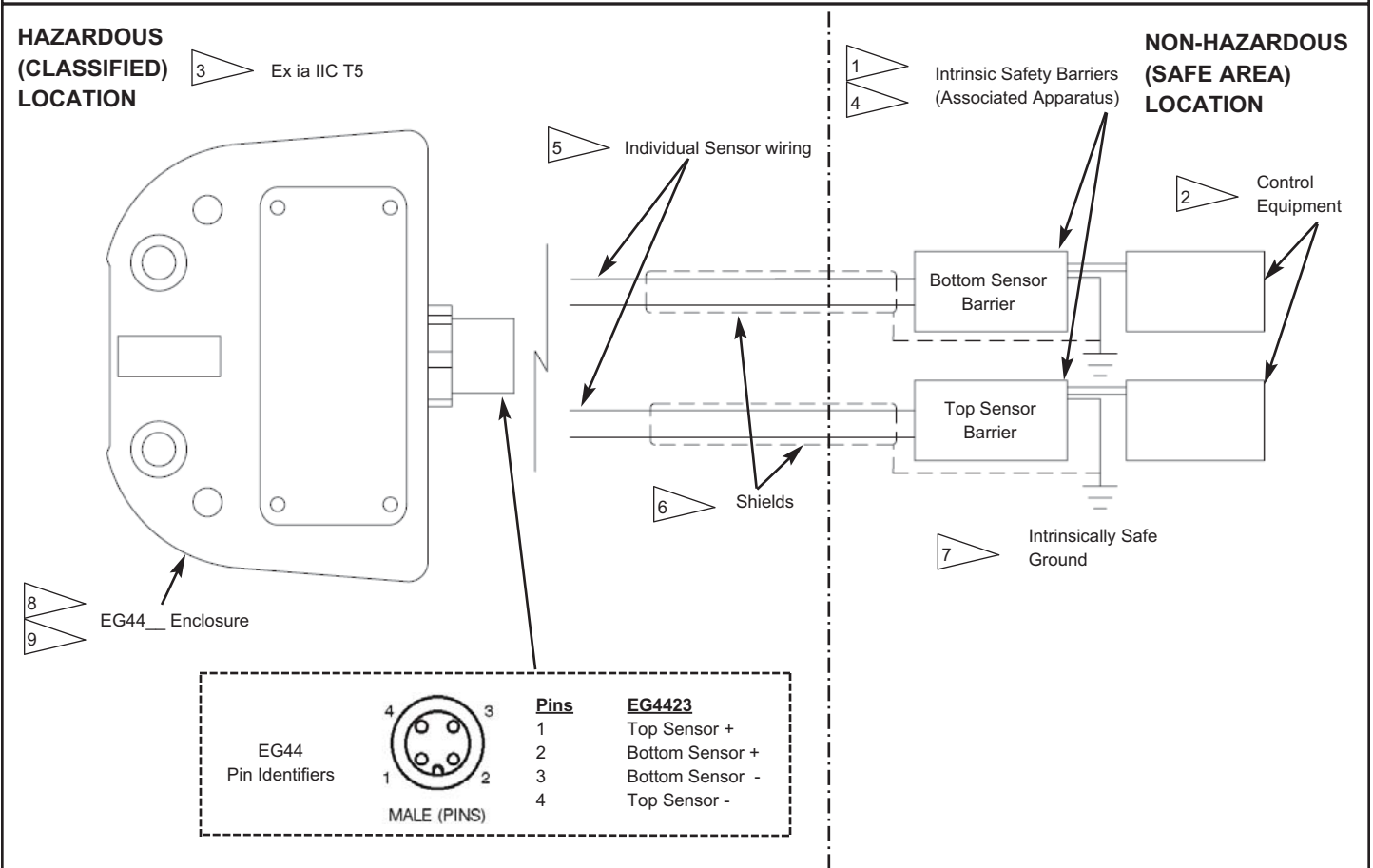

INSTALLATION NOTES Intrinsically Safe Installations: (Ex ia IIC T5):

EG44___ Entity Parameters: $U_i = 22 \text{ Vdc}$; $I_i = 120 \text{ mA}$; $C_i = 98 \text{ nF}$; $L_i = 1.56 \text{ mH}$; $P_i = 2.0 \text{ W}$

1. The Entity Concept allows interconnection of intrinsically safe apparatus with associated apparatus when the following is true: $U_i \geq U_o$; $I_i \geq I_o$; $P_i \geq P_o$; $C_o \geq C_i + C_{\text{cable}}$, $L_o \geq L_i + L_{\text{cable}}$.
2. For Installations in Europe, control room equipment connected to intrinsically safe associated apparatus shall not use or generate more than the marked U_m of the associated apparatus.
3. Installation in Europe shall be in accordance with latest editions of the wiring practices for the country of origin.
4. For Installations in Europe, the Associated Apparatus must be ATEX approved. Associated apparatus manufacturer's installation drawing must be followed when installing this equipment.
5. To maintain intrinsic safety, wiring associated with each sensor or solenoid coil wiring must be run in separate cables or separate shields connected to intrinsically safe (associated apparatus) ground. Each Sensor and Solenoid coil shall be wired as separate intrinsically safe circuits.
6. Conduit Grounding - Upon installation verify electrical continuity between conduit and ground terminal.
7. Resistance between Intrinsic Safe Ground and earth ground must be less than 1.0 ohm.

WARNING:

8. Parts of the enclosure are non-conducting and may generate an ignition-capable level of electrostatic charge under certain extreme conditions. The user should ensure that the equipment is not installed in location where it may be subjected to external conditions (such as high-pressure steam) which might cause a build-up of electrostatic charge on non-conducting surfaces. Additionally, cleaning of the equipment should only be done with a damp cloth.
9. Substitution of components may impair hazardous location safety.
10. No revision to drawing without prior FM Approval.

EG44C or P ___ models approved for Intrinsically Safe Installations: IS Class I,II and III; Division 1, Groups A,B,C,D,E,F,G

EG4423C or P ___ *

*Note: Any Visual Indicator/Trigger Assembly option is approved

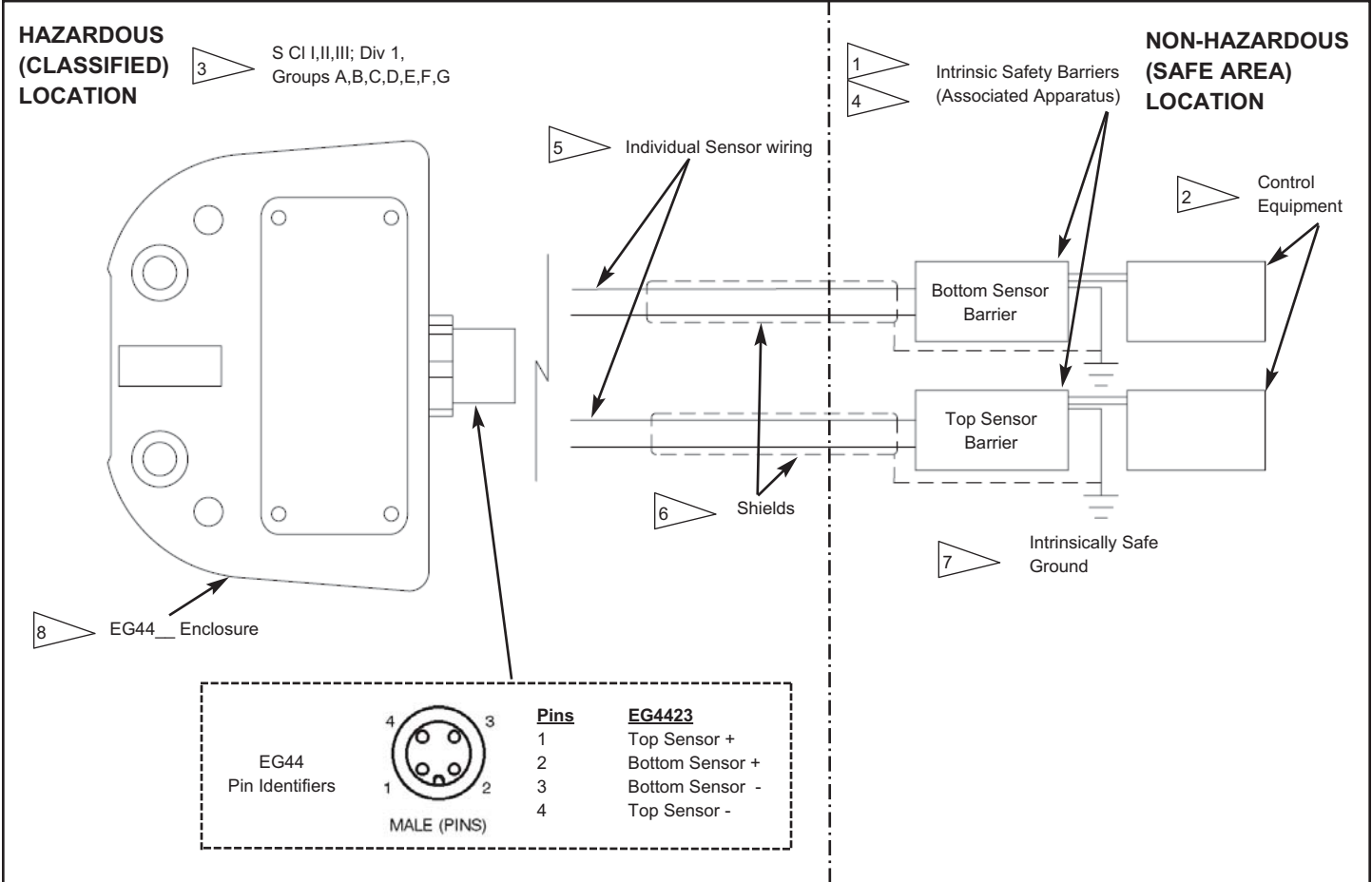

INSTALLATION NOTES:

EG44 ___ Entity Parameters: U_i (Vmax) = 22 Vdc; I_i (Imax) = 120 mA ; C_i = 98 nF; L_i = 1.56 mH; P_i = 2.0 W

1. $U_o \leq U_i$ (Vmax); $I_o \leq I_i$ (Imax); $C_a \geq C_i + C_{cable}$, $L_a \geq L_i + L_{cable}$.
2. Control equipment connected to barrier must not use or generate more than 250 Vrms or Vdc.
3. Installation should be in accordance with ANSI/ISA RPA12.6.01 "Installation of Intrinsically Safe Systems for Hazardous (Classified) Locations" and the National Electrical Code (ANSI/NFPA 70) or in accordance with the Canadian Electric Code.
4. Associated apparatus manufacturer's installation drawing must be followed when installing this equipment.
5. To maintain intrinsic safety, wiring associated with each sensor or solenoid coil wiring must be run in separate cables or separate shields connected to intrinsically safe (associated apparatus) ground. Each Sensor and Solenoid coil shall be wired as separate intrinsically safe circuits.
6. Shield Grounding - Upon installation verify electrical continuity between shield and ground terminal.
7. Resistance between Intrinsic Safe Ground and earth ground must be less than one ohm.

WARNING:

8. Parts of the enclosure are non-conducting and may generate an ignition-capable level of electrostatic charge under certain extreme conditions. The user should ensure that the equipment is not installed in location where it may be subjected to external conditions (such as high-pressure steam) which might cause a build-up of electrostatic charge on non-conducting surfaces. Additionally, cleaning of the equipment should only be done with a damp cloth.
9. Substitution of components may impair hazardous location safety.

FISCO Concept

The FISCO Concept allows the interconnection of intrinsically safe apparatus to associated apparatus not specifically examined in such combination. The criterion for such interconnection is that voltage (V_{max}), the current (I_{max}), and the power (P_i), which intrinsically safe apparatus can receive and remain intrinsically safe, considering faults, must be equal to or greater than the voltage (U_o, V_o, V_t), the current (I_o, I_{sc}, I_t), and the power (P_o) which can be provided by the associated apparatus (supply unit). In addition, the maximum unprotected residual capacitance (C_i) and inductance (L_i) of each apparatus (other than the terminators) connected to the Fieldbus must be less than or equal to 5nF and 10 μ H respectively.

In each I.S. Fieldbus segment only one active source, normally the associated apparatus, is allowed to provide the necessary power for the Fieldbus system. The allowed voltage (U_o, V_o, V_t) of the associated apparatus used to supply the bus must be limited to the range of 14V d.c. to 24V d.c. All other equipment connected to the bus cable has to be passive, meaning that the apparatus is not allowed to provide energy to the system, except to a leakage current of 50 μ A for each connected device. Separately powered equipment needs a galvanic isolation to insure that the intrinsically safe Fieldbus circuit remains passive.

The cable used to interconnect the devices must comply with the following parameters:

Loop resistance R' : 15 - 150 ohm/KM

Inductance per unit length L' : 0.4 - 1mH/KM

Capacitance per unit length C' : 80 - 200nF/KM

$C' = C'$ line to line + $\frac{1}{2} C'$ line to shield, if both lines are floating with respect to shield

or

$C' = C'$ line to line + C' line to shield, if one line is connected to shield

Trunk Length: \leq 1000 meters

Spur Length: \leq 30 meters

Splice Length: \leq 1 meters

FM Approved line terminators must be used on each end of the trunk cable that have the following parameters:

$R = 90 - 100$ ohms

$C = 0.0 - 2.2\mu$ F

(See Page 12 for Installation Diagram and Notes)

Intrinsic Safety (FISCO) Hazardous Location Installation Diagram

Pub # 105149revE

**EG93C or P ___ * models approved for Intrinsically Safe (FISCO) Installations:
IS Class I,II and III; Division 1, Groups A,B,C,D,E,F,G**

*Note: All Entry options and Visual Indicator/Trigger Assembly options are approved

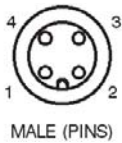
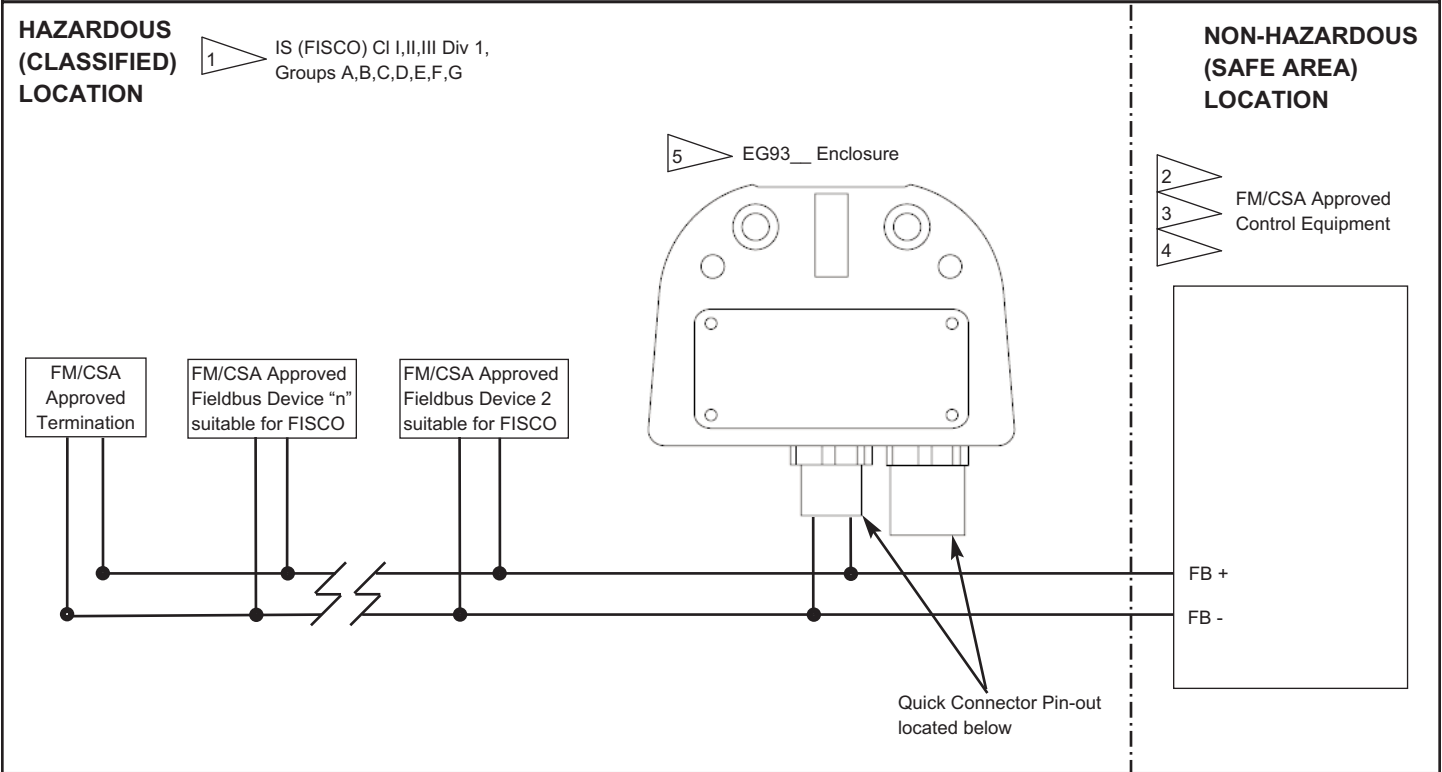

Pins	EG9323
1	FB -
2	FB +
3	N/C
4	N/C



Pins	EG9324
1	FB -
2	FB +
3	N/C
4	N/C



Solenoid Connection (Female Socket)	
1	SIM JMPR
2	SIM JMPR
3	Solenoid -
4	Solenoid +

INSTALLATION NOTES:

EG93 ___ Entity Parameters (FISCO): U_i (V_{max})=30 Vdc; I_i (I_{max})=380 mA; C_i 0.0 nF; L_i =0.0 mH; P_i =5.32 W

1. Installation shall be in accordance with ANSI/ISA RPA12.6.01, ANSI/NFPA 70, and the National Electrical Code or in accordance with the Canadian Electric Code.
2. Control equipment must be FM or CSA Approved Associated Apparatus suitable for FISCO.
3. Control equipment connected to FISCO barrier must not use or generate more than 250Vrms or Vdc.
4. Resistance between FISCO Intrinsically Safe Ground and earth ground must be less than 1.0 Ohm.

WARNING:

5. Parts of the enclosure are non-conducting and may generate an ignition-capable level of electrostatic charge under certain extreme conditions. The user should ensure that the equipment is not installed in location where it may be subjected to external conditions (such as high-pressure steam) which might cause a build-up of electrostatic charge on non-conducting surfaces. Additionally, cleaning of the equipment should only be done with a damp cloth.
6. Substitution of components may impair hazardous location safety.
7. Approval Agency controlled Installation Diagram. No revision to diagram allowed without prior Factory Mutual or Approval Agency authority.

Non-Incendive Field Wiring Apparatus Installation Drawing

Pub # 105149revE

EG93C or P ____ * models approved for Non-Incendive Field Wiring Apparatus: NI Class I,II and III; Division 2, Groups A,B,C,D,F,G

*Note: All Entry options and Visual Indicator/Trigger Assembly options are approved

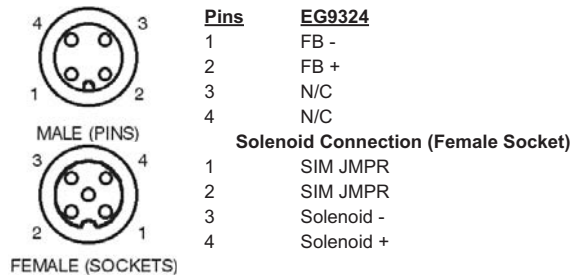
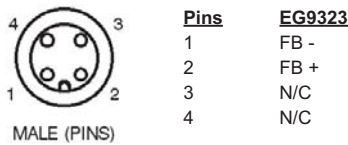
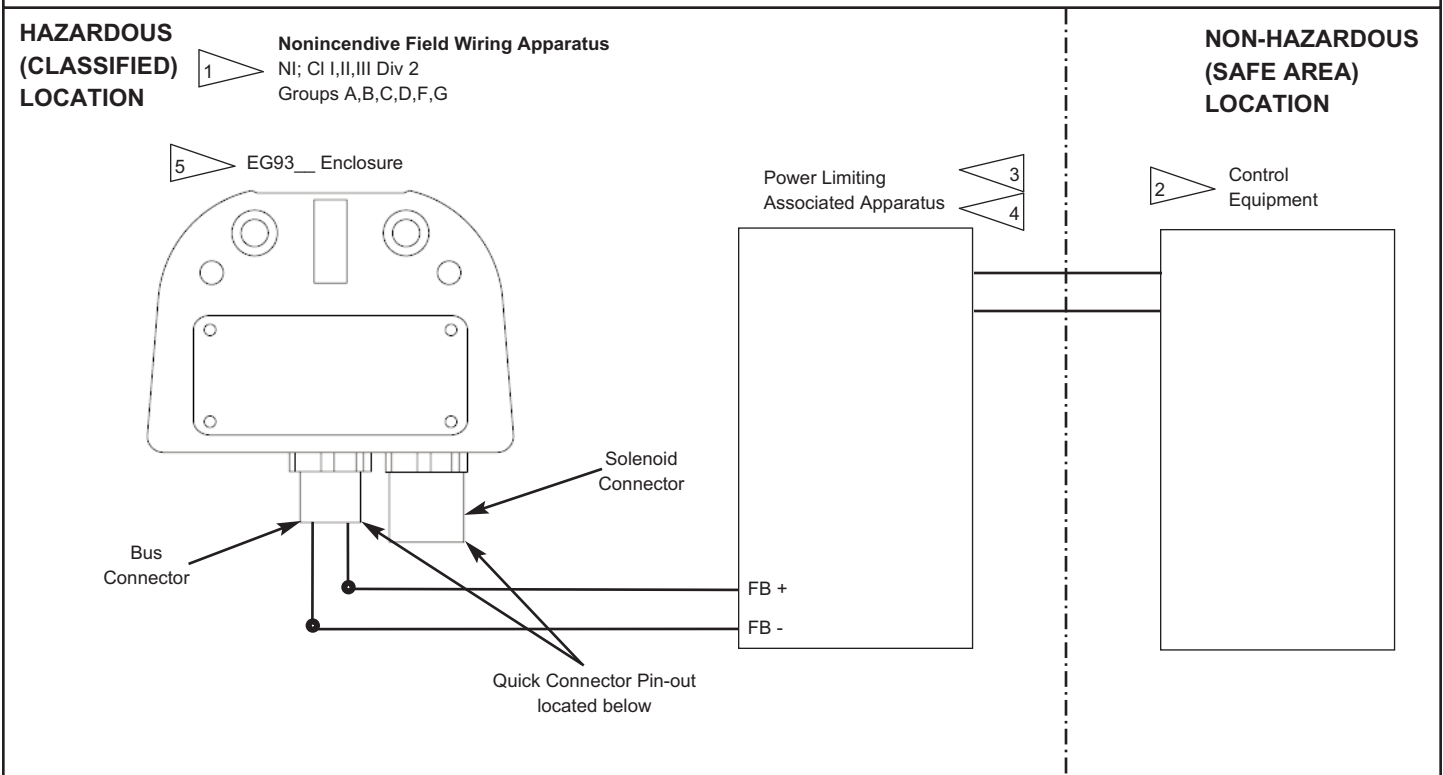

INSTALLATION NOTES:

Entity Parameters: EG93 ____ : $U_i = 30 \text{ Vdc}$; $I_i = 380 \text{ mA}$; $C_i = 0.0 \text{ nF}$; $L_i = 0.0 \text{ mH}$; $P_i = 5.32 \text{ W}$

1. Installation shall be in accordance with ANSI/ISA RPA12.6.01, ANSI/NFPA 70, and the National Electrical Code.
2. Control equipment must be FM approved to supply power in Class I, Division 2 Areas.
3. Power Limiting Associated Apparatus must satisfy the conditions: $V_{oc} \text{ or } V_t \leq U_i$, $I_{sc} \text{ or } I_t \leq I_i$, $C_a \geq C_i + C_{cable}$, $L_a \geq L_i + L_{cable}$ of the EG93 ____ Entity Parameters
4. Manufacturer's associated non-incendive field wiring apparatus installation drawing must be followed when installing this equipment.
5. Parts of the enclosure are non-conducting and may generate an ignition-capable level of electrostatic charge under certain extreme conditions. The user should ensure that the equipment is not installed in location where it may be subjected to external conditions (such as high-pressure steam) which might cause a build-up of electrostatic charge on non-conducting surfaces. Additionally, cleaning of the equipment should only be done with a damp cloth.
6. Substitution of components may impair hazardous location safety.

EG96C or P_* and EG97C or P_* models approved for Non-Incendive Field Wiring Apparatus: NI Class I,II and III; Division 2, Groups A,B,C,D,F,G

*Note: All Entry options and Visual Indicator/Trigger Assembly options are approved

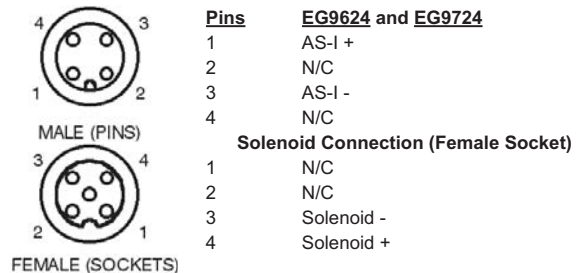
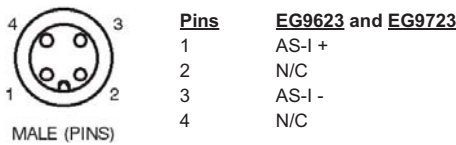
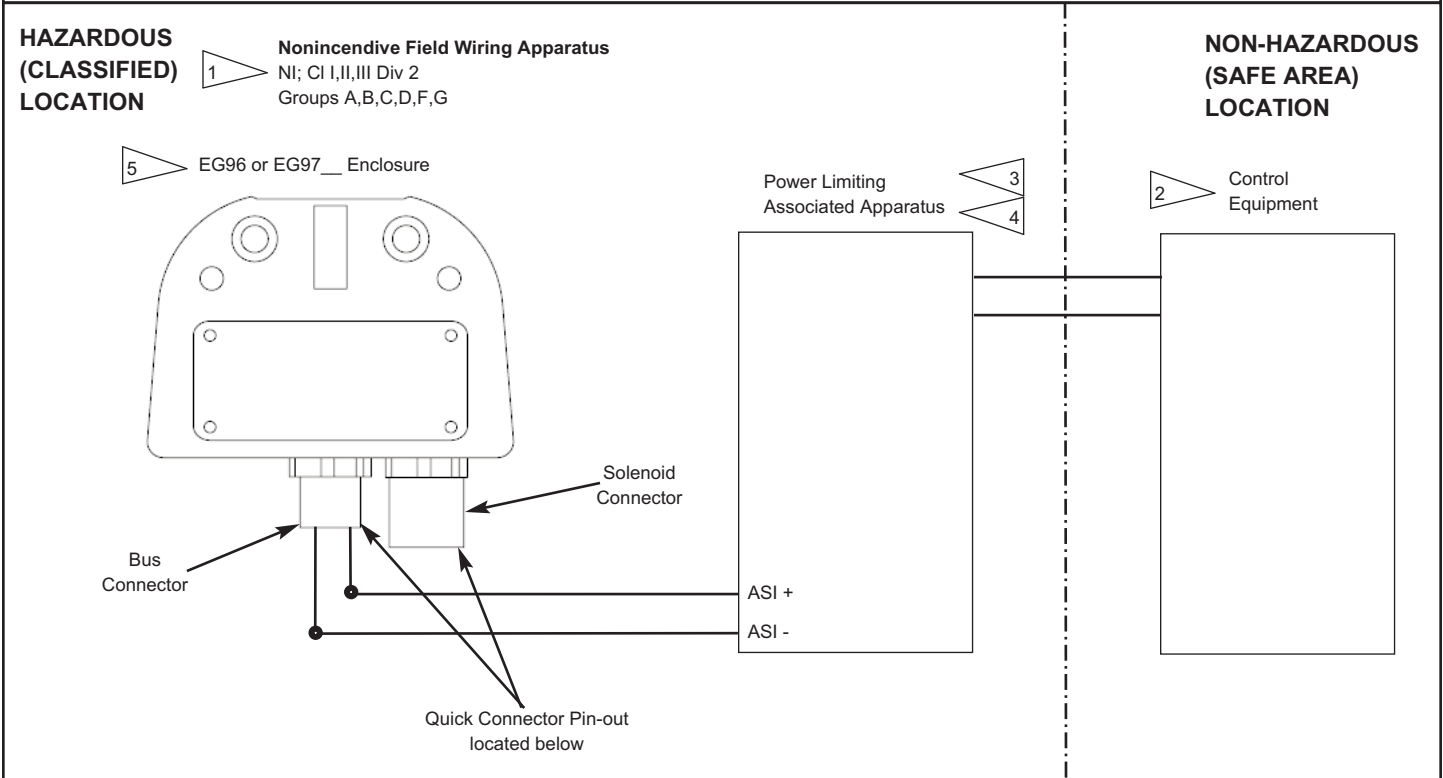

INSTALLATION NOTES:

Entity Parameters: EG96 or EG97___: $U_i = 37 \text{ Vdc}$; $I_i = 150 \text{ mA}$; $C_i = 0.0 \text{ nF}$; $L_i = 0.0 \text{ mH}$; $P_i = 3.0 \text{ W}$

1. Installation shall be in accordance with ANSI/ISA RPA12.6.01, ANSI/NFPA 70, and the National Electrical Code.
2. Control equipment must be FM approved to supply power in Class I, Division 2 Areas.
3. Power Limiting Associated Apparatus must satisfy the conditions: $V_{oc} \text{ or } V_t \leq U_i$, $I_{sc} \text{ or } I_t \leq I_i$, $C_a \geq C_i + C_{cable}$, $L_a \geq L_i + L_{cable}$ of the EG96 or EG97___ Entity Parameters
4. Manufacturer's associated non-incendive field wiring apparatus installation drawing must be followed when installing this equipment.
5. Parts of the enclosure are non-conducting and may generate an ignition-capable level of electrostatic charge under certain extreme conditions. The user should ensure that the equipment is not installed in location where it may be subjected to external conditions (such as high-pressure steam) which might cause a build-up of electrostatic charge on non-conducting surfaces. Additionally, cleaning of the equipment should only be done with a damp cloth.
6. Substitution of components may impair hazardous location safety.

DECLARATION OF CONFORMITY

Manufacturer:

Neles USA Inc. dba StoneL
26271 US Highway 59
Fergus Falls, Minnesota 56537 USA

Products:

Eclipse EN Series – Valve Position Monitors and Valve Communication Terminals
Eclipse EG Series – Valve Position Monitors and Valve Communication Terminals

Model - Type	Certificates / Directives / Standards	Marking
EN Series EG Series	EU Type Examination Certificate FM08ATEX0015X ATEX 2014/34/EU EN 60079-0:2012+A11:2013, EN 60079-11:2012 EMC 2014/30/EU EN 60947-5-2:2007/A1:2012	 2809 ATEX II 1 G Ex ia IIC T5 Ga
EN Series EG Series	EMC 2014/30/EU EN 60947-5-2:2007/A1:2012	

ATEX Notified Bodies for EU Type Examination Certificates:

FM Approvals Europe Ltd., Dublin, Ireland (Notified Body Number 2809)

We declare under our sole responsibility that the products, as described, are in conformity with the listed standards and directives.

Fergus Falls, 10th January 2021



Bryan Beckman, Quality Manager
Authorized Person of the Manufacturer

SPECIFIC CONDITIONS OF USE / MARKING

For EN and EG Series – FM08ATEX0015X	
Specific Conditions of Use - Notes	Marking
1. Parts of the enclosure are non-conducting and may generate an ignition-capable level of electrostatic charge under certain extreme conditions. The user should ensure that the equipment is not installed in a location where it may be subjected to external conditions which might cause a build up of electrostatic charge on non-conducting surfaces. Additionally, cleaning of the equipment should be done only with a damp cloth.	ATEX II 1 G Ex ia IIC T5 Ga Ta = -40°C to +80°
For EN and EG Series – FM17US0239X / FM17CA0123X	
Specific Conditions of Use - Notes	Marking
1. Parts of the enclosure is constructed from plastic. To prevent the risk of electrostatic sparking the plastic surface should only be cleaned only with a damp cloth.	NI / I-II-III / 2 / ABCDEFG I / 2 / IIC / T5 Gc IS / I, II, III / 1 / ABCDEFG – 105193 CI I / Zone 0 / AEx ia IIC T6...T1 Ga CI I / Zone 0 / Ex ia IIC T6...T1 Ga *See Approval Certificates for applicable models / type codes.

Neles

Vanha Porvoontie 229, P.O. Box 304, FI-01301
VANTAA, Finland.
Tel. +358 20 483 150. Fax +358 20 483 151

neles.com

StoneL

26271 US Hwy 59, Fergus Falls, MN 56537 USA.
Tel. +1 218 739 5774.

stonel.com